

Forgotten Wrecks of the First World War

HMD John Mitchell

Site Report



May 2018

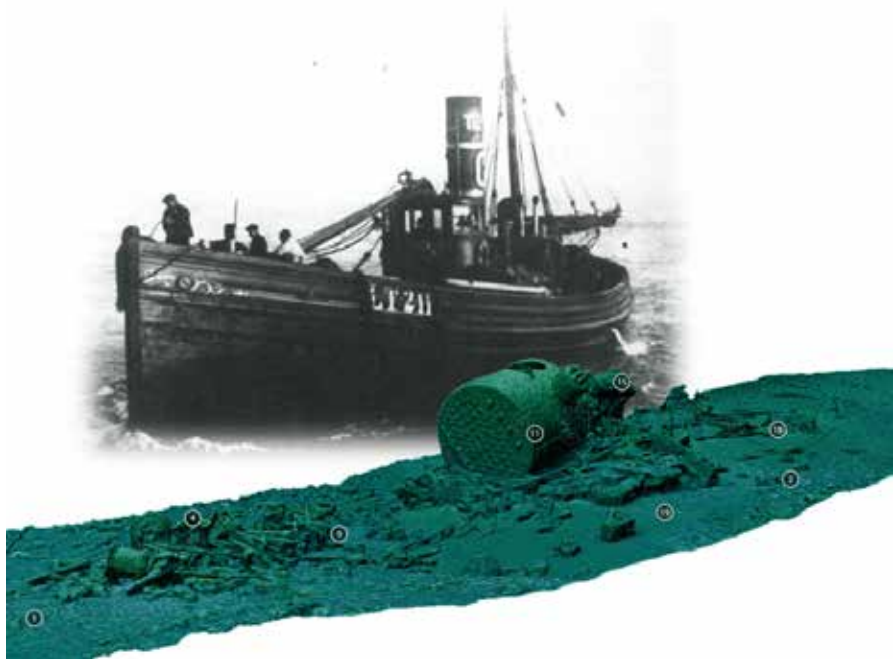

Table of Contents

i Acknowledgments	3
ii Copyright Statement	3
iii List of Figures	3
1. Project Background	4
2. Methodology	4
2.1 Desk Based Research	4
2.1.1 Online Information/Sources	4
2.1.2 Records at The National Archives.....	5
2.1.3 Other Historical Sources.....	5
2.2 Associated Artefacts	5
2.3 Site Visit/Fieldwork	5
3. Vessel Biography: HMD <i>John Mitchell</i>	5
3.1 Vessel Type and Build	6
3.2 Pre-war Career	6
3.3 First World War Use & Loss.....	7
3.4 Associated Vessels	7
3.5 Post-loss Activity	7
4. Seabed Remains.....	8
4.1 Site Location and Environment	8
4.2 Archaeological Methodology	8
4.3 Description of Surviving Vessel Remains.....	8
5. Recovered Artefacts.....	22
6. Site Significance & Potential Further Research	24
7. Bibliography	24
8. Appendices	26
8.1 <i>John Mitchell's</i> gun.....	26

i Acknowledgments

The Forgotten Wrecks of the First World War project was generously funded by the Heritage Lottery Fund through their Heritage Grants Programme.

MAT would like to thank all the volunteers who gave up their time to help with research and to dive on the *John Mitchell* including Roger Burns and Peter Crick. Special thanks to dive boat skipper and historian Dave Wendes for generously sharing his knowledge and records.

MAT staff involved in the recording: Garry Momber, Jan Gillespie, Brandon Mason, Martin Davies, Jane Maddocks, Keith Clark.

MAT staff involved in research and reporting: Amanda Bowens.

ii Copyright Statement

This report has been produced by the MAT with the assistance of funding provided by the Heritage Lottery Fund through their Heritage Grants Programme. Unless otherwise stated all images are copyright of the MAT.

iii List of Figures

FIGURE 1: DRIFTER <i>JOHN MITCHELL</i> AT SEA. IMAGE COURTESY OF THE PORT OF LOWESTOFT RESEARCH SOCIETY COLLECTION	6
FIGURE 2: THE POSITION OF THE WRECK OF HMD <i>JOHN MITCHELL</i>	8
FIGURE 3: ORTHO-RECTIFIED COMPOSITE IMAGE OF THE WRECK OF <i>JOHN MITCHELL</i> , BOWS TO RIGHT OF PHOTO.....	9
FIGURE 4: LOOKING FORWARDS IN THE VESSEL, THE ENGINE AND BOILER LEAN TO PORT	9
FIGURE 5: WOODEN HULL PLANKING BURIED IN THE SEABED	10
FIGURE 6: STEM BAND LEANING TO PORT (GUN IN FOREGROUND).....	11
FIGURE 7: DAVIT AND GUN IN THE BOW OF THE VESSEL	11
FIGURE 8: THE GUN HAS FALLEN TO PORT AND LIES ON ITS SIDE IN THE FRONT OF THE VESSEL	12
FIGURE 9: THE GUN ON ITS PEDESTAL (STEM BAND LOWER LEFT CORNER)	12
FIGURE 10: THE TOP OF THE GUN	13
FIGURE 11: THE <i>JOHN MITCHELL</i> 'S 3-POUNDER HOTCHKISS GUN	13
FIGURE 12: PILE OF OBJECTS AFT OF THE DAVIT ON THE STARBOARD SIDE.....	14
FIGURE 13: READY-USE AMMUNITION IN PILES AND BOXES BETWEEN THE BOILER AND BOW ON THE STARBOARD SIDE.....	14
FIGURE 14: WOODEN FRAMES AND HULL PLANKING FROM PORT SIDE OF VESSEL (FORWARD OF BOILER)	15
FIGURE 15: STEERING POSITION MECHANISM (TOP LEFT), THE FORWARD END OF THE BOILER BOTTOM RIGHT	16
FIGURE 16: FORWARD END OF THE BOILER.....	16
FIGURE 17: BOILER LEANING TO PORT (FROM THE PORT SIDE) DIVERS RECORDING ENGINE BEHIND	17
FIGURE 18: TUBES INSIDE THE BOILER	17
FIGURE 19: AFT END OF THE BOILER AND DISLODGED BOILER CRADLE/MOUNT (FRONT RIGHT).....	18
FIGURE 20: ENGINE FROM STARBOARD SIDE, LP CYLINDER AFT/LEFT	18
FIGURE 21: VERTICAL COMPOUND ENGINES	19
FIGURE 22: ENGINE FROM PORT SIDE, PROP SHAFT LOWER RIGHT	19
FIGURE 23: FORWARD END OF ENGINE, PORT SIDE	19
FIGURE 24: STEEL BOX (RIGHT) ON STARBOARD SIDE IMMEDIATELY AFT OF ENGINE	20
FIGURE 25: AREA OF JUMBLED STRUCTURE AROUND ENGINE AND BOILER	20
FIGURE 26: SPARE PROPELLER AND UNIDENTIFIED FEATURE (BOTTOM RIGHT).....	21
FIGURE 27: ARTEFACTS RECOVERED FROM THE WRECK OF HMD <i>JOHN MITCHELL</i>	23

1. Project Background

Forgotten Wrecks of the First World War is a Heritage Lottery Funded project which is dedicated to raising the profile of a currently under-represented aspect of the First World War. While attention is often focused on the Western Front and major naval battles like Jutland, historic remains from the war lie, largely forgotten, in and around our seas, rivers and estuaries.

With over 1,100 wartime wrecks along England's south coast alone, the conflict has left a rich heritage legacy and many associated stories of bravery and sacrifice. These underwater memorials represent the vestiges of a vital, yet little known, struggle that took place on a daily basis, just off our shores. The study and promotion of these archaeological sites presents a unique opportunity to better interpret them and improve physical and virtual access.

The project focuses on underwater and coastal sites between Kent and Cornwall, which include merchant and naval ships, passenger, troop and hospital ships, U-boats, ports, wharfs, buildings and foreshore hulks. These sites, under water and on the foreshore, have been degrading and deteriorating due to natural and human processes for approximately 100 years and, as a result, are extremely fragile. In many cases, this project represents a final opportunity to record what remains on the seabed and foreshore before it is lost forever.

The project aims to characterise the nature and extent of the maritime First World War archaeological resource surviving on the south coast's seabed and around the coast. This will enable an understanding of maritime activity just off our shores during the conflict and provide a window onto some of the surviving sites. While it will not be possible to visit and record all c.1,100 vessels dating to the First World War, lost off the south coast of England, a representative sample of sites have been selected for more detailed study, analysis and interpretation. This report collates information collected during the project, relating to one of the south coast's First World War wrecks, namely that of His Majesty's Drifter (HMD) *John Mitchell*.

2. Methodology

General detail on the methodologies employed during the project are outlined within the *Forgotten Wrecks of the First World War: Project Methodology Report*. This report section concentrates on approaches and resources in relation to HMD *John Mitchell*.

2.1 Desk Based Research

2.1.1 Online Information/Sources

Relatively few online sources relating to the *John Mitchell* were found.

The wreck of HMD *John Mitchell* is listed in the National Record of the Historic Environment (NRHE), Monument Number: 1233966, NMR Number: SY 97 NE 145. The record was last updated in 2015.

The Wrecksite.eu record for *John Mitchell* uses Wendes (2006) as reference source and there are currently no records relating to the dive site.

Naval-history.net's index to British Warships 1914 – 1918 (Dittmar & Colledge) provides information about *John Mitchell's* build, requisition, armament, use and loss.

The Crew List Index Project (CLIP) website provided useful information about the registration and career of the *John Mitchell*.

Pastscape	http://www.pastscape.org.uk/hob.aspx?hob_id=1233966
Wrecksite EU	https://wrecksite.eu/wreck.aspx?243156
Naval-history.net	http://www.naval-history.net/WW1NavyBritishShips-Dittmar2.htm#J
CLIP	http://www.crewlist.org.uk/data/vesselsnum?officialnumber=135765&submit=search

2.1.2 Records at The National Archives

A number of documents held at The National Archives (TNA), Kew were consulted for information likely to be helpful in relation to the *John Mitchell*. Of particular interest were BT 110/338/33 Certificate of British Registry, Particulars of Ship: *John Mitchell* and ADM 137/578 Home Waters Telegrams, 14 – 16 November 1917. The vessel log for *John Mitchell* does not appear to have survived and no official enquiry seems to have been held, though this is not unusual for 1917, given there was no loss of life.

2.1.3 Other Historical Sources

Information about the location and activity of *John Mitchell* prior to its loss has been gleaned from a number of contemporary newspaper reports (in addition to the documents listed above at The National Archives).

From Tree to Sea: Building of a Wooden Steam Drifter (Frost 1985) was useful for vessel layout, fixtures and fittings information.

2.2 Associated Artefacts

While the Forgotten Wrecks project had a non-recovery policy, where possible, the project aimed to record and ‘virtually reunite’ artefacts historically recovered from the Forgotten Wrecks. Eight objects were identified as having been recovered from the wreck of the *John Mitchell* and recorded (see Section 5).

2.3 Site Visit/Fieldwork

Forgotten Wrecks, HLF-funded diving from the dive boat *Wight Spirit* took place on the wreck of the *John Mitchell* on 24 June 2015, diving conditions were excellent, with exceptional visibility.

Dives aimed to assess the condition of the remains and obtain a site sketch, measurements and a photographic survey.

A total of six divers undertook a total of 234 minutes diving on the wreck. The dive team used self-contained breathing apparatus (SCUBA) with a breathing gas of nitrox using accelerated decompression procedures.

3. Vessel Biography: HMD *John Mitchell*

The *John Mitchell* (Figure 1) was a fishing vessel requisitioned by the Admiralty during the First World War, it was chosen as one of the Forgotten Wrecks case study sites because it was typical of many such vessels used to handle anti-submarine nets, and perform many other primarily inshore duties such as mine clearance and patrolling. Some 40 similar vessels are known to have sunk in the Channel during the First World War. The remains of the *John Mitchell* are relatively undisturbed, its location only recently having been discovered.



Figure 1: Drifter *John Mitchell* at sea. Image courtesy of the Port of Lowestoft Research Society Collection

3.1 Vessel Type and Build

John Mitchell was a carvel-built, single-decked fishing drifter with two masts and a semi-elliptical stern. Built at Lowestoft by Samuel Richards & Co in 1913, and registered on 9 August that year, *John Mitchell*'s official number was 135765. Built of wood, the vessel's length overall was 85' (25m), beam 20' (6m), with a draught of 9' (2.7m). Powered by steam, *John Mitchell*'s engine was built, also in 1913, by Crabtree and Co Ltd, Great Yarmouth. It is described on the registration documents as a compound surface condensing direct acting engine with two inverted cylinders (11" and 24" diameters). The single-ended steel horizontal boiler was built by Palmers Ship and Iron Co Ltd, of Hebburn on Tyne. Producing 38 HP the vessel could reach 9 knots (BT 110/338/33).

3.2 Pre-war Career

The *John Mitchell* was owned by the Colonial Fishing Company Ltd of Lowestoft and apparently named after the General Manager of the company at that time. *John Mitchell* was used as a fishing vessel (fishing registration LT.211), for the whole two years of civilian life, until requisitioned by the Admiralty (Admiralty number: 1065) in February 1915. Though registered and based in Lowestoft, *John Mitchell* roved the whole Eastern seaboard, as evidenced by reports of its catch by the *Aberdeen Press and Journal* on 25 August 1913 and 29 June 1914 (St Peter's Day) which cite *John Mitchell* amongst the English and Scottish drifters landing the largest herring catches at Lerwick. The drifter's master during this time was one E Fergusson.

3.3 First World War Use & Loss

Commercial fishing drifters like the *John Mitchell* were built to withstand heavy weather. While designed to deploy and retrieve fishing drift nets, they were readily adapted to a range of war duties and more than 1,300 of them were hired by the Admiralty during the First World War, with approximately 40 being lost in the Forgotten Wrecks project area. Steam drifters were mainly engaged in minesweeping duties, escort, supply, repair and transport. A few were employed as hospital vessels and even Q-ships (heavily armed vessels disguised as merchant ships that aimed to lure U-boats into making a surface attack). More unusual roles for hired steam drifters included a hydrophone training ship, aircraft tender, submarine depot vessel and a chaplain's tender.

The *John Mitchell* was hired by the Admiralty in February 1915 and, armed with a single 3-pounder gun, began work as a net vessel, maintaining and patrolling anti-submarine nets. Historic documents relating to the *John Mitchell* are difficult to find, but small clues about the ship's war service can be found through incidental material. For example, a young deck hand from the drifter, Charles Frederick Turrell, tragically fell between moored boats and died in February 1915. A newspaper report into the coroner's enquiry (*Dover Express* 1915) states that the vessel was moored at Wellington Docks, Dover, suggesting that, at this time, the *John Mitchell* was serving with the Dover Auxiliary Patrol. Two years later, in April 1917, another crew member, 24 year old George Black McGregor from Banff, Scotland, died due to heart disease at Poole, Dorset while serving on the *John Mitchell*, which it would seem was now operating out of Poole.

Under the Admiralty, *John Mitchell* was "Parented" by three base vessels – HMS *Halcyon* at Lowestoft, HMS *Attentive* at Dover, and HMS *Manzanita* at Taranto in the Mediterranean (Greatwarforum.org). There is no record of when the drifter was re-patriated to the UK but on 14 November 1917 *John Mitchell* collided with the steamship SS *Bjerka* which was on passage from London to Newport. While known to have been 'on Admiralty duties', no information could be found relating to the port of departure or intended return on the day the drifter was lost. The Master was George Blowers RNR; and a telegram, catalogued under 'Home Waters Telegrams, 14-16 November 1917' provides brief details about the sinking: "Regret to inform you loss of Drifter 1065 John Mitchell by collision 0145 14/11 in latitude 50 32 north, 001 42 west, with SS Bjerka bound Newport from London. All saved and brought into harbour. Steamer proceeded. SE by E 10 miles from Anvil Point." (TNA, ADM 137/578).

3.4 Associated Vessels

The vessel that collided with *John Mitchell*, causing it to sink was SS *Bjerka*, a Norwegian, single-decked steel screw steamer with length 206ft (63m), breadth 33ft (10m) and depth 15ft (4.5m) (Lloyd's Register 1916/17).

The crew list and ship's log for *Bjerka* covering November 1917 is held by the Maritime History Archive, Memorial University in Newfoundland. Unfortunately, the log contains no reference to the collision with *John Mitchell*.

3.5 Post-loss Activity

Following a report from a local shell fisherman who had got his lobster pots caught in some wreckage, dive boat skipper and historian Dave Wendes first investigated the site in 2009. It is thought that fewer than a dozen people have ever dived the site (2018).

4. Seabed Remains

4.1 Site Location and Environment

The wreck of the *John Mitchell* lies approximately 12 miles south west of the Needles at a depth of approximately 40m on a sand, shingle and rock seabed (Figure 2).



Figure 2: The position of the wreck of HMD *John Mitchell*

4.2 Archaeological Methodology

The site assessment of HMD *John Mitchell* included MAT dives which aimed to:

- Swim the length of the wreck and produce a site sketch with notable features;
- Lay a baseline along the wreck to determine length and measure distances to significant features;
- Locate, draw and measure relevant features; and
- Undertake a photographic survey for 3D modelling.

The photographic survey, with visibility in excess of 30m, resulted in 684 photographs of the wreck that were used to produce a 3D digital scale model (publicly accessible at: <https://skfb.ly/FBHN>) and an ortho-rectified composite image of the wreck site (Figure 3). Photos from this dive are included in this report and will form part of the project archive.

4.3 Description of Surviving Vessel Remains

The wreck of the *John Mitchell* lies orientated approximately east/west, with bows to the east. While none of the wooden hull structures survives above the seabed, Figure 3 shows how site integrity is

intact and the drifter's fixtures, fittings and contents lie in situ on the seabed, their positions relative to each other and the remains of the ship preserved.

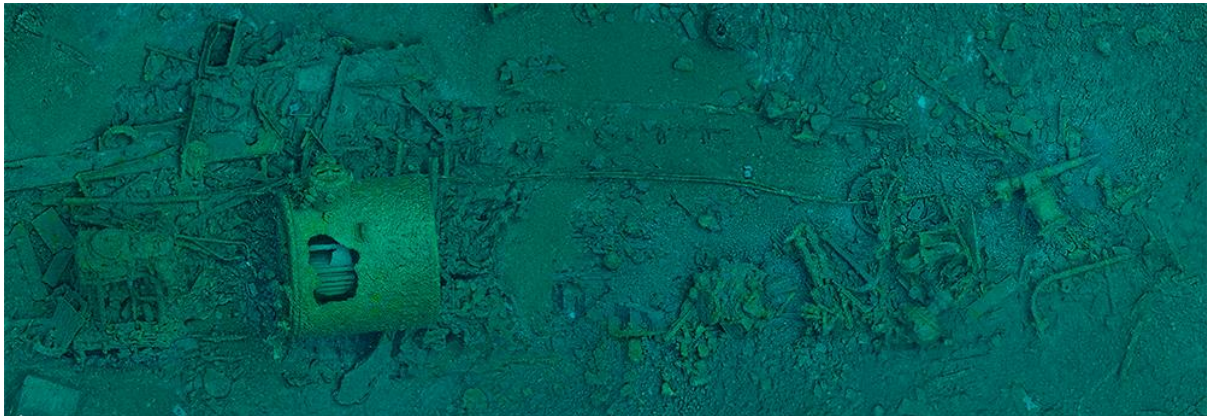

Figure 3: Ortho-rectified composite image of the wreck of *John Mitchell*, bows to right of photo

Typically for wooden steamships, the boiler and engine are the most visible and upstanding features on the site. They are aligned with each other and the vessel's stemband, all leaning approximately 45 degrees to port (Figure 4).



Figure 4: Looking forwards in the vessel, the engine and boiler lean to port

While the starboard side of the drifter no longer survives, sections of wooden frames and planking of the port side can be seen (Figure 5), particularly just forward of the boiler, revealing that at least part of the port side of the hull survives buried in the sand and shingle seabed.



Figure 5: Wooden hull planking buried in the seabed

The wooden stem post no longer survives but the steel stem band that would have protected it does (Figure 6).



Figure 6: Stem band leaning to port (gun in foreground)

Immediately aft of the stem band, in the bow area of the vessel, a davit lies on the starboard side, alongside the ship's gun (Figure 7).



Figure 7: Davit and gun in the bow of the vessel

Dittmar and Colledge (Navalhistory.net) state that *John Mitchell* carried a 3pdr gun. The gun on the wreck (Figure 8 to 11) was studied, via the 3D digital model of the site (<https://skfb.ly/FBHN>), by MAT volunteer Rob Hale who concluded that it was a QF 3-pounder Hotchkiss gun (see Section 8.1).



Figure 8: The gun has fallen to port and lies on its side in the front of the vessel

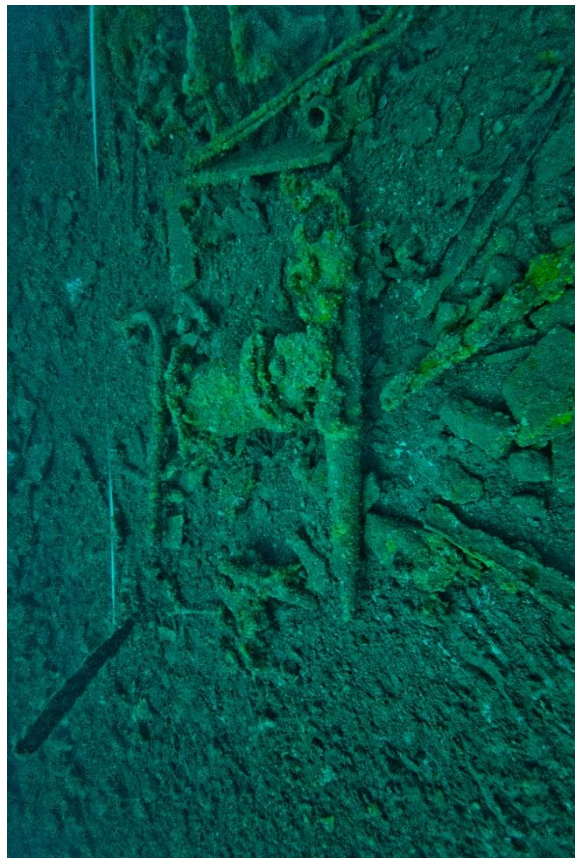

Figure 9: The gun on its pedestal (stem band lower left corner)



Figure 10: The top of the gun



Figure 11: The *John Mitchell's* 3-pounder Hotchkiss gun

Immediately aft of the davit and gun, on the starboard side, is a jumbled collection of objects (Figure 12) that includes a capstan, two Admiralty pattern anchors, a possible fairlead or spar fitting as well as ready-use ammunition for the gun, some in boxes (Figure 13).



Figure 12: Pile of objects aft of the davit on the starboard side



Figure 13: Ready-use ammunition in piles and boxes between the boiler and bow on the starboard side

Moving aft, before reaching the boiler, wooden frames and planking from the port side of the hull can be seen in the sand (Figure 14).

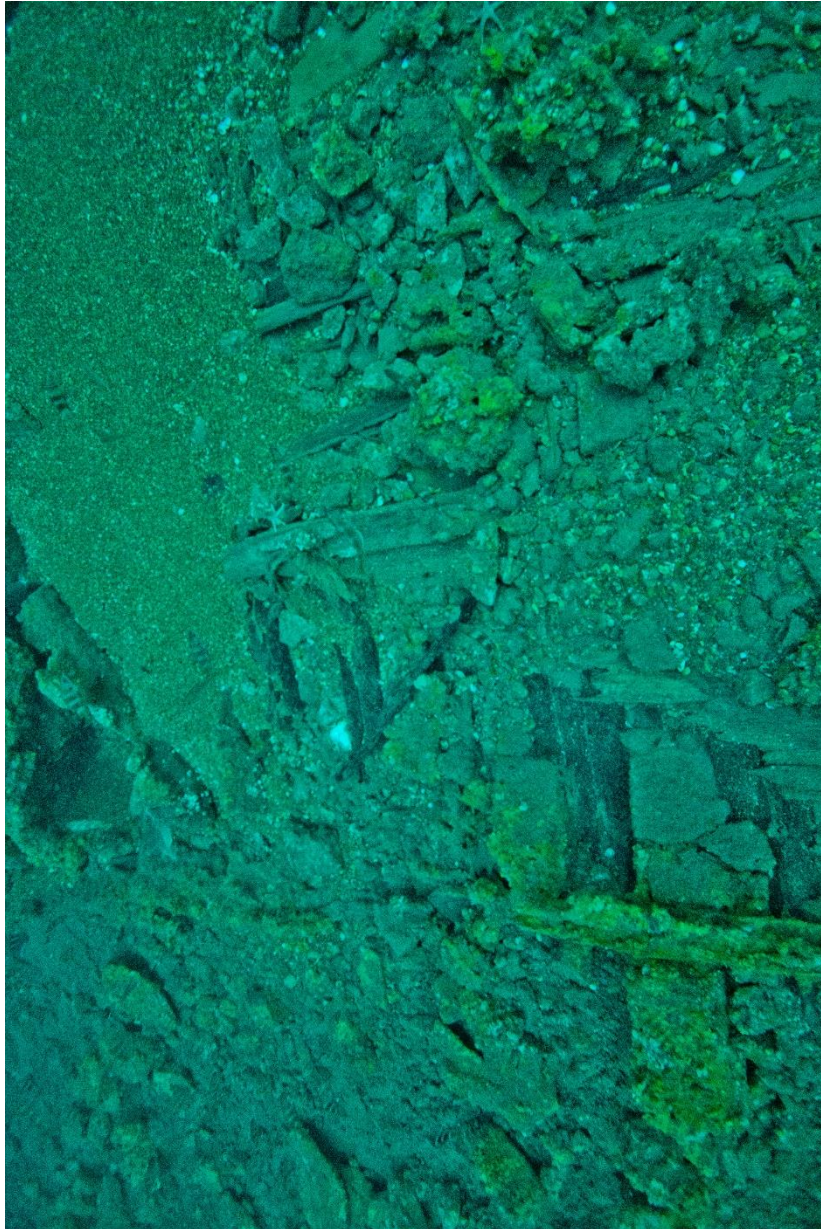

Figure 14: wooden frames and hull planking from port side of vessel (forward of boiler)

On the port side of the site, immediately forward of the boiler, the steering position mechanism lies on the seabed, having presumably fallen from the wheelhouse as the vessel broke apart (Figure 15).



Figure 15: Steering position mechanism (top left), the forward end of the boiler bottom right

The boiler is a standard Scotch marine boiler (Figure 16), single-ended with two furnaces. Divers measured it to have a length of 220cm and diameter for 225cm.



Figure 16: Forward end of the boiler

The boiler leans to port (Figure 17) and a hole in the top on the starboard side reveals the internal tubes (Figure 18).



Figure 17: Boiler leaning to port (from the port side) divers recording engine behind

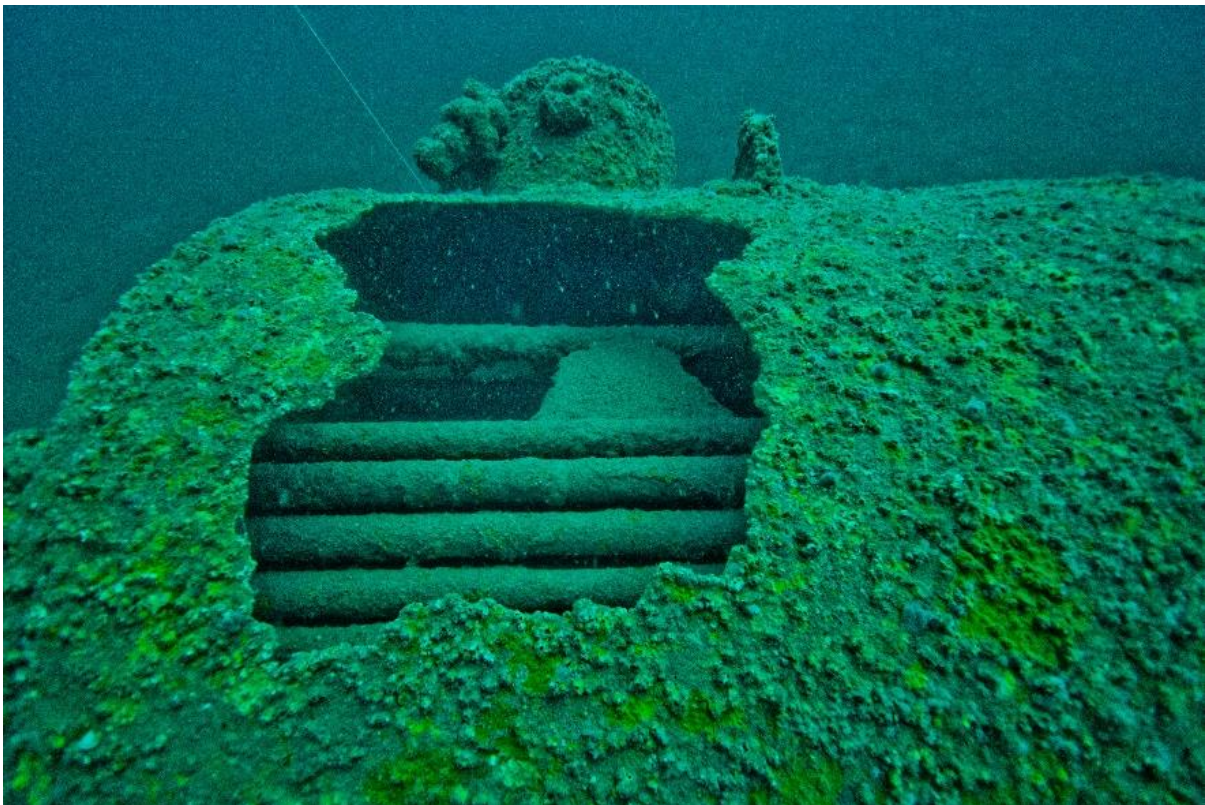

Figure 18: Tubes inside the boiler

The aft end of the boiler reveals the end of the tubes and the two furnace fronts, with fire doors and ash pits. The cradle/mount that the boiler would have sat in has been pulled backwards in the vessel (Figure 19).



Figure 19: Aft end of the boiler and dislodged boiler cradle/mount (front right)

The engine sits immediately behind the boiler, also leaning to port (Figure 20).

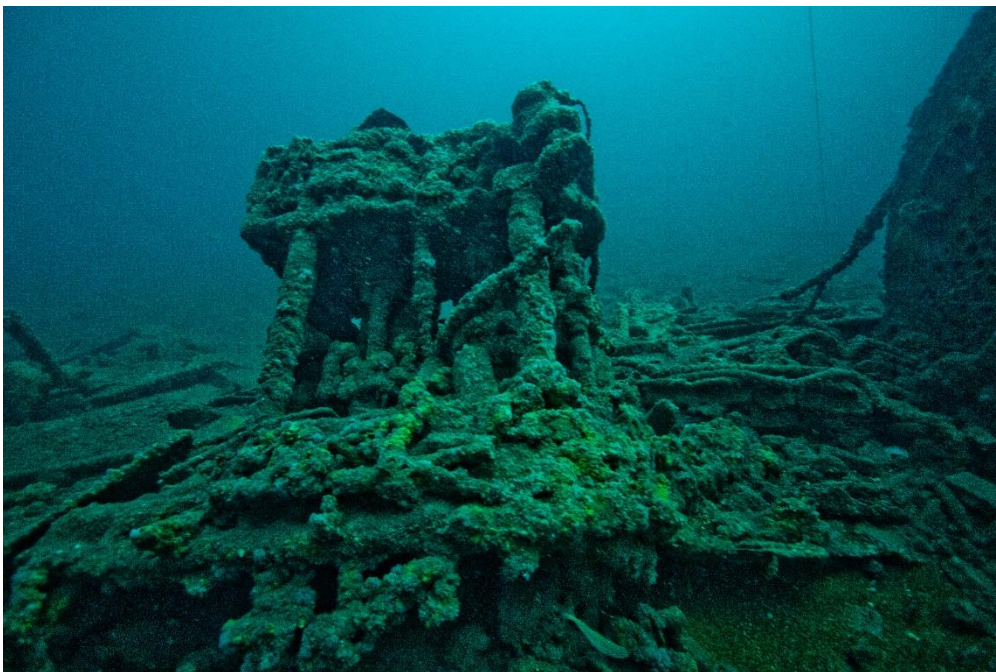

Figure 20: Engine from starboard side, LP cylinder aft/left

According to the vessel registration documents, it is a 2-cylinder vertical compound engine, built by Crabbtree and Co Ltd., Great Yarmouth in 1913.

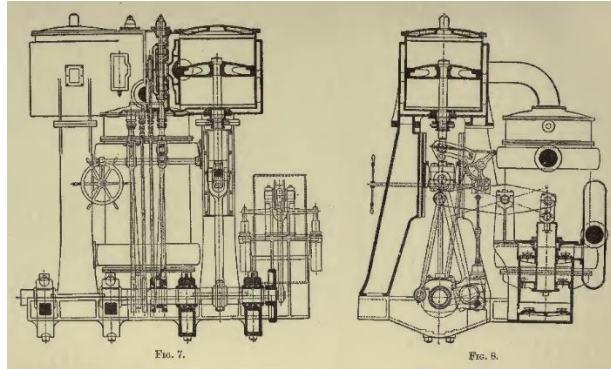
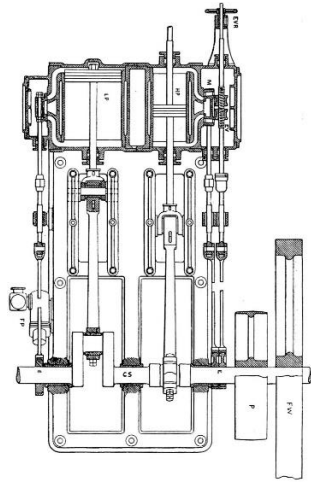

Figure 21: Vertical Compound Engines
 Above: Vertical (Compound) Engine (Sennett & Oram 1899)
 Left: Cross compound engine, plan section (Ripper 1913)

The prop shaft can be seen running down the centreline of the vessel, aft of the engine (Figure 22).



Figure 22: Engine from port side, prop shaft lower right



Figure 23: Forward end of engine, port side

On the starboard side, just aft of the engine is a box (Figure 24). It appears to be made of steel, with the approximate dimensions: height 50cm, width 90cm depth 60+cm, this was most likely a fresh water tank.



Figure 24: Steel box (right) on starboard side immediately aft of engine

In the area around and between the boiler and engine, significant quantities of ship structure, fixtures and fittings lie in a jumbled heap (Figure 25), including hull planking, metal bars and fairleads.



Figure 25: Area of jumbled structure around engine and boiler

Towards the stern of the vessel a spare propeller can be seen half buried in the sand, alongside a mechanism of unknown purpose, comprising joined sections of metal bar with round cross-section (Figure 26).



Figure 26: Spare propeller and unidentified feature (bottom right)

5. Recovered Artefacts

The following artefacts, recovered from the *John Mitchell*, have been identified:

	
<p>Builder's name plate. Brass, cast relief writing on a black background with outer gold rim. Dimensions (mm) - L: 310, W: 240, H: 6</p>	<p>Rum container: 2 gallon flagon marked 'Lydon & Co. Bonded store merchants, Swansea'. Dimensions (mm) - W: 210, H: 240</p>
	
<p>A boiler water sight gauge. Brass with lower copper exit pipe. Lower valve inscribed 'C' & 'Hopkinson's Patent Huddersfield'. Three valves: upper two control the viewing chamber. Upper section 40x10cm comprises a glass tube behind a glass viewing panel, protected by a brass frame of three sturdy pillars. Dimensions (mm) - L: 230, W: 180, H: 700</p>	<p>Signal lamp. Brass with heavy clear glass window 6x12.5cm. Inscribed 'Player & Mitchell Manufacturers, Birmingham' in lower section, below glass. Domed head hinged on one side, sealed opposite with knurled knob. Base is minus oil chamber, perforated with air holes. Head threaded. Handle on rear. Dimensions (mm) - W: 150, H: 300</p>



	
<p>2x brass shell casings. Appear to be 47mm (3-pdr) calibre. Each has a base cap. Dimensions (mm) - W: 63, H: 383</p>	<p>Ship's bell, extremely corroded. Very few engraving marks remaining, but noticeable indentations where marks were previously (possibly giving ship's name). An accompanying bell tang (51x51x7mm) is in cleaner condition. Dimensions (mm) - W: 202, H: 137</p>
	
<p>Solid metal bar and fixing - the bracket for hanging the ship's bell. Fixing to wall connects to a 60cm long bar that curves back on itself to bell pivot hanger. Dimensions (mm) - L: 400, W: 70, H: 300</p>	

Figure 27: Artefacts recovered from the wreck of HMD John Mitchell

The artefacts identified as having been recovered from the wreck of the *John Mitchell* comprise an eclectic collection in terms of artefact type and material. The builder's name plate helped identify the wreck, confirming the builder, date of build and yard number, the Port of Lowestoft Research Society confirming that *John Mitchell* was built at yard number 188.

Typical ship fixtures and fittings (bell, bell bracket, boiler gauge) are also represented, the further study of which could provide information on steamship technology, fixtures, fittings and materials used in the years leading up to and during the First World War. In addition, comparison of these artefacts with material from other wrecks could help with the identification of currently unidentified sites. The ship's bell, while significantly corroded, is an iconic artefact from any ship and the rum

container and signal lamp highlight the human element and serve as a reminder that with every wreck, like the *John Mitchell*, comes related stories of people dealing with adversity.

6. Site Significance & Potential Further Research

Assessing Boats and Ships 1914 – 1938 recognises that:

“Fishing vessels of this date are rarely, if ever, archaeologically investigated. Although much information exists relating to the industry in the form of historical documentation and oral histories, archaeology has contributed little. The vessels present as wrecks therefore offer a potentially unique source of information. On this basis, all fishing vessel wrecks are potentially of special interest. However, due to their large number, it is likely that this alone will not be enough to confer special interest.”

The report continues: *“One factor relating to the use of fishing vessels which would most certainly contribute to special interest is the requisitioning of fishing vessels by the Royal Navy. A significant proportion of fishing vessel wrecks (73 records) is recorded as having been hired by the Admiralty. Such vessels may also be regarded of special interest through their representation of measures undertaken by the Admiralty to supplement the military vessels in operation during the period.”* (Wessex Archaeology 2011: 55 - 56).

John Mitchell, built as a fishing drifter and hired by the Admiralty for war work, presents an interesting case study, being a vessel type and use currently under-represented in the archaeological record. There are opportunities for recording construction detail of the port side of the hull where it is exposed in the seabed. The two-cylinder engine is a late example (1913) of the use of this kind of technology and, being relatively well preserved, could contribute to the knowledgebase in this area. Similarly, further study of artefacts (recovered and still on the wreck) afford opportunities to improve knowledge in this area (see Section 5).

7. Bibliography

Books, Reports and Documents

Aberdeen Press and Journal (1914) “Fine Lerwick Fishing” 29 June 1914, page 11.

Dover Express (1915) “Drowned in the Wellington Dock: Drifter Hand’s Sad Death” 12 February 1915.

Frost, T. 1985. *From Tree to Sea: Building of a Wooden Steam Drifter*. Terence Dalton.

Lloyd’s Register of Ships 1916/17.

Ripper, W. 1913. *Heat Engines*. Longmans, Green and Co. London. Sennett, R. & Oram H. 1899. *The Marine Steam Engine: a treatise for engineering students young engineers and officers of the Royal Navy and Mercantile Marine*. Longmann’s, Green & Co. The National Archives, UK, BT 110/338/33
Certificate of British Registry, Particulars of Ship: John Mitchell The National Archives, UK, ADM 137/578
Home Waters Telegrams, 14 – 16 November 1917. Wendes, D. 2006. *South Coast Shipwrecks: East Dorset and Wight 1870 – 1979*. David Wendes.

Websites

CLIP “Crew List Index Project: John Mitchell” Accessed May 21, 2018.

<http://www.crewlist.org.uk/data/vesselsnum?officialnumber=135765&submit=search>

Greatwarforum.org “Drifter John Mitchell Feb 1915” Accessed May 21, 2018. [http://1914-](http://1914-1918.invisionzone.com/forums/topic/188011-drifter-john-mitchell-feb-1915/?tab=comments#comment-1832154)

[1918.invisionzone.com/forums/topic/188011-drifter-john-mitchell-feb-](http://1914-1918.invisionzone.com/forums/topic/188011-drifter-john-mitchell-feb-1915/?tab=comments#comment-1832154)

[1915/?tab=comments#comment-1832154](http://1914-1918.invisionzone.com/forums/topic/188011-drifter-john-mitchell-feb-1915/?tab=comments#comment-1832154)

Naval-history.net “An Index to ‘British Warships 1914 – 1919’ by F J Dittmar & J J Colledge” Accessed

May 21, 2018. <http://www.naval-history.net/WW1NavyBritishShips-Dittmar2.htm#J>

Pastscape. “John Mitchell.” Accessed May 21, 2018.

http://www.pastscape.org.uk/hob.aspx?hob_id=1233966

Wrecksite.eu. “John Mitchell” Accessed May 21, 2018. <https://wrecksite.eu/wreck.aspx?243156>

8. Appendices

8.1 *John Mitchell's* gun

Identification of deck gun on the wreck of the HMT *John Mitchell* by examination of computer generated 3D model MAT Volunteer: Rob Hale

Methodology

Upon establishing the area of interest within the 3D model, in this case the bow mounted deck gun, I initially performed a 360 degree sweep in order to gain a full appreciation of the object. By moving around the gun, viewing it from multiple angles, I was able to ascertain whether certain features were symmetrical, i.e. appeared on both sides of the gun, and also gain a fairly clear sense of scale and depth; something which can be problematic when relying purely on traditional 2D imaging. Navigating around the model was relatively straightforward and intuitive, affording a unique perspective of a wreck site and providing an extremely high degree of detail, visible from a multitude of angles.

To determine which of the potential models of gun was represented here I collected a number of photographs and drawings of the two possible weapons from the internet. The two guns in question being the QF 3-pounder Hotchkiss and the Ordnance QF 3-pounder Vickers. It became apparent that the clearest way to compare the gun in the 3D model was to view it in profile (whilst still taking into consideration any information gleaned from my initial sweep around the entirety of the gun). To this end I maintained a viewing position at approximately a 90 degree angle to the gun/sea floor.



Appendix 8.1, Fig. 1

Profile of the gun extracted from the 3D model (available at: <https://skfb.ly/FBHN>)

Although in this instance the outline of the artefact was very clear, I nevertheless opted to take a screen capture of the object and the immediate surroundings. Subsequently I utilised photo editing software to isolate the gun from the background seabed. This image of the gun's profile (Figure 1) could then be compared very easily to the example photographs that I had previously collated. Whilst creating this image was not strictly necessary in this instance, it is a procedure which can be completed with relative ease, and in other cases it may assist in the comparison process. Further it may enable additional image processing to be conducted; ultimately this may elicit details which were not initially apparent. Manipulation of the shadow and tone on the surface of the object might, for example, reveal subtle elements of design and form which might otherwise not be apparent.

After comparison to representative images of the two potential weapons it became evident that there were three primary areas which would provide the easiest means of establishing identity. These areas were: the breech section (marked in red on the diagrams), the recoil cylinders (marked in blue), and

the barrel (marked green). The gun mount would seem to be of less use for establishing identity. Although the weapon on HMT *John Mitchell* appears to be fixed on a pedestal mounting, a variety of different mounts were utilised at varying times and in varying situations.

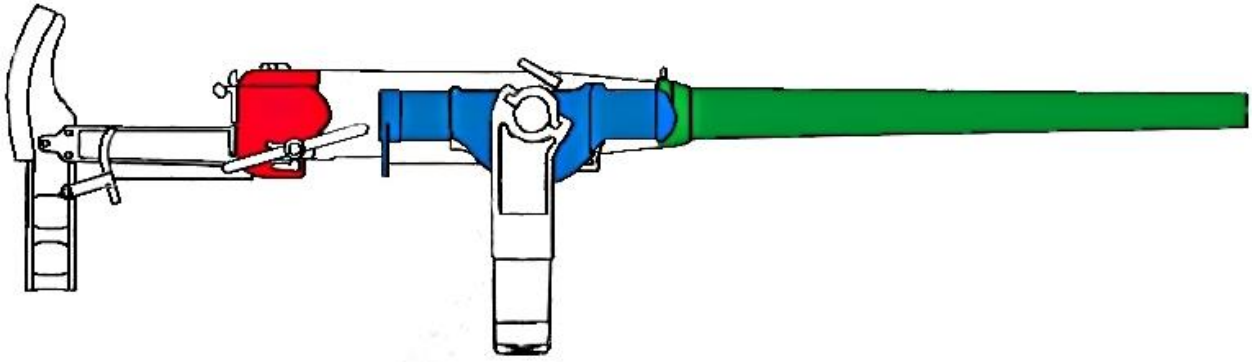

Appendix 8.1, Fig. 2
QF 3-pounder Hotchkiss

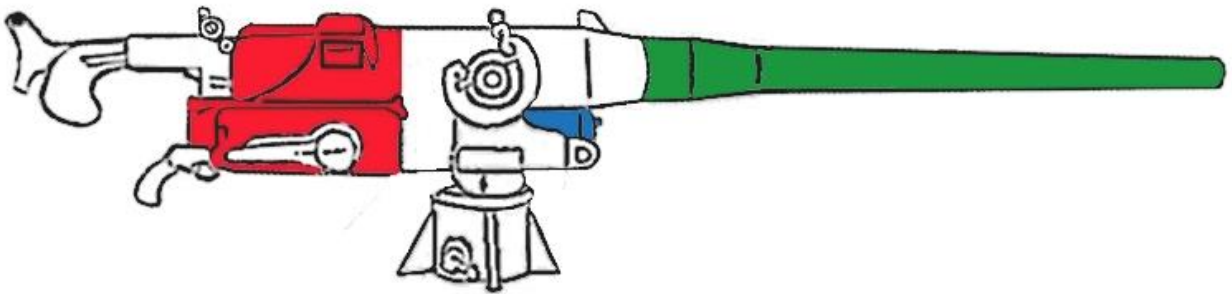

Appendix 8.1, Fig 3.
Ordnance QF 3-pounder Vickers

Hotchkiss:

- Breech housing: Shorter and somewhat squarer in appearance.
- Cylinders: Two cylinders, positioned on the side of the main body of the gun. One cylinder located on each side.
- Barrel: Upon leaving the main superstructure of the gun the barrel runs in a straight taper.

Vickers:

- Breech housing: Slightly longer, larger, and more rectangular in shape.
- Cylinders: Only a single cylinder, which is mounted centrally underneath the main body of the gun.
- Barrel: Alters in width and angle of taper, rather than being uniform (see Figure 4).



Appendix 8.1, Fig. 4

After comparison of these three key areas, it is apparent that the deck gun located on the wreck of the *John Mitchell* is almost certainly a QF 3-pounder Hotchkiss. The profile of the barrel, and most significantly, the existence of symmetrical recoil cylinders, would clearly indicate that the weapon is not a Vickers. As several versions of the Hotchkiss gun appear to have been produced it may be possible, given further research and analysis, to determine the precise Mark of the weapon and also the mounting to which it is attached.

Research: QF 3-pounder Hotchkiss

The QF 3-pounder Hotchkiss was a light 47-mm naval gun, the first of the modern QF (quick-firing) artillery to be adopted by the Royal Navy. The “QF” designation first came into use in the late 19th century and in the context of naval armaments it was used for relatively small calibre guns firing fixed ammunition. This 'fixed ammunition' consisted of a complete round formed from a brass cartridge case containing the propellant and projectile in one unit, thus enabling higher firing rates. Although originally developed by the French arms manufacturer Hotchkiss et Cie, it was subsequently built under licence in Britain by Elswick Ordnance Company, entering service in 1886. At least two primary versions of the original single-barrel gun were produced; the Mark I was of monobloc construction made of a single casting, while the Mark II was a built-up design which incorporated a specially reinforced barrel in which an inner tube of metal stretches and enlarges to transmit stress to outer cylinders.

Originally deployed in locations where the 6-pounder gun was considered to be too heavy, its primary function was to offer defence against new small fast vessels such as torpedo boats, and later submarines. It was also used ashore as a coastal defence gun and later occasionally saw service as an anti-aircraft gun. In addition to the traditional single-barrel model, a 5-barrel Gatling-type 3-pounder revolver cannon was also completed, entering service with both the Russian and US Navies. Prior to World War I the original single-barrel version was found on most small cruisers, designated for the anti-torpedo boat role. By the middle of the First World War the Hotchkiss gun had, however, become largely obsolescent. As such, it was gradually supplanted by the more powerful Ordnance QF 3-pounder Vickers gun. Despite its technological limitations the Hotchkiss continued to be utilised in certain circumstances, generally for auxiliary duties. Ultimately the Royal Navy, in common with other nations, found that these small-calibre projectiles were too light to be effective and many guns were converted following the First World War to undertake training and ceremonial duties.

The availability of numbers, its simple design, and light weight resulted in its continued use on small vessels. Indeed, despite their age many were brought back into service yet again during World War II, with some 1,950 examples still available for deployment. The change of use, to that of a training and saluting gun, ultimately meant that a high number of these weapons survived until World War II when they were converted back to their offensive role. Once again they operated in their traditional role, providing armed protection on merchant vessels. Additionally they were employed, during the early

part of the war, at ports throughout the British Empire to counter against possible attacks by motor torpedo boats.

Although eventually superseded in the port protection role by a more capable replacement (the QF 6-pounder), these venerable armaments continued to be used as subcalibre guns for gunnery practice right up until the 1950s. When production finally ceased some 2,950 units had been manufactured. In addition to seeing service throughout the British Empire the Hotchkiss gun was also to be found in the inventories of several other nations. The armed forces of Australia, France, Russia, the United States, and Poland all operated variants of the 3-pounder Hotchkiss.

Weapon Specifications:

Gun Characteristics:

Gun Length	2.048 m (80.6 in)
Bore Length	1.881 m (74.1 in)
Chamber Volume	0.705 dm ³ (43 in ³)
Rate Of Fire	20-30 rounds per minute
Approximate Barrel Life	6,000 rounds

Ammunition:

Type	Fixed
Weight of Complete Round	HE - 2.6 kg (5.7 lbs.)
Projectile Types and Weights	HE -1.5 kg (3.3 lbs.)
Projectile Length	Complete Round 54.2 cm (21.4 in)

Range:

Elevation	With 1.5 kg (3.3 lbs.) HE Shell
20.7 degrees	5,944 m (6,500 yards)
45 degrees	7,200 m (7,900 yards)
Maximum AA Ceiling	3,000 m (10,000 feet)
Effective AA Range	1,100 m (1,200 yards)

Mounts / Turrets:

Designation	Single Low-Angle (LA) Mountings: Mark I and Mark I* Single High-Angle (HA) Mountings: Mark IV HA, Mark V HA and Mark VI HA
Weight	0.8 mt (0.7 tons)
Elevation	Marks I and I*: -5 / +25 degrees Mark IV: N/A Mark V: -5 / +70 degrees Mark VI: -5 / +60 degrees
Elevation Rate	Manually operated only
Train	360 degrees
Train Rate	Manually operated only
NB: Marks I, I* and IV were pre-war and World War I mountings. Marks V and VI were produced during World War II. The Mark VI used rubber recoil buffers. Some Mark I mountings were converted to HA types and then designated as Mark IC HA. These had an elevation range of -8 to +60 degrees.	

Sources:

NavWeaps http://www.navweaps.com/Weapons/WNBR_3pounder_H_mk1.php

Wikipedia https://en.wikipedia.org/wiki/QF_3-pounder_Hotchkiss