

Identifying a Mystery Shipwreck

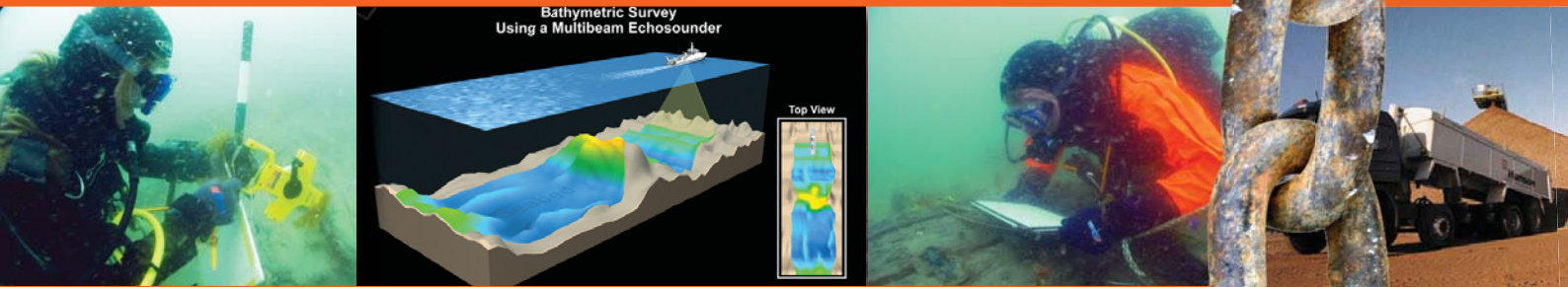

Bathymetric Survey Using a Multibeam Echosounder

A cross-curricular resource for KS3

Marine
Aggregate Levy
Sustainability Fund
MALSF

Hampshire & Wight Trust
for
MARITIME
Archaeology

Identifying a Mystery Shipwreck

This booklet has been produced by the Hampshire & Wight Trust for Maritime Archaeology (HWTMA) thanks to funding from the Marine Aggregate Levy Sustainability Fund (MALSF).

While aimed at KS3 (Years 7-9) pupils, much of the content can be adapted to suit older or younger age groups. The booklet has been designed to enable pupils to work across the curriculum, developing an understanding of how different subjects are applied in the workplace and how people from different disciplines and professions work together. Curriculum links are indicated down the outside edge of each page.

Notes for Teachers

A **Content Outline** and **Teachers' Notes** are available on the HWTMA website. Please be sure to read these in conjunction with this booklet. They offer advice on how the booklet can be used.

Ideally, pupils working through this booklet will have access to the internet. Web-links for research tasks and further activities are provided throughout, indicated by the 'WWW' icon.



Questions and tasks appear in blue boxes like this one.....

...or orange ones like this.

Definitions:
appear in green boxes like this



Templates, Question & Answer Sheets

A range of these have been created to facilitate class-room sessions using this booklet. They are downloadable as Word files at:

www.hwtma.org.uk/mwtpdownloads

The HWTMA website will also host case studies showing how this booklet has been used within schools, so if you have any feedback in this regard, HWTMA would be delighted to hear from you:

Hampshire & Wight Trust for Maritime Archaeology
Room W1/95,
National Oceanography Centre,
Empress Dock,
Southampton
SO14 3ZH

Tel: 02380 237300

Email: info@hwtma.org.uk

Produced by:



Funded by:

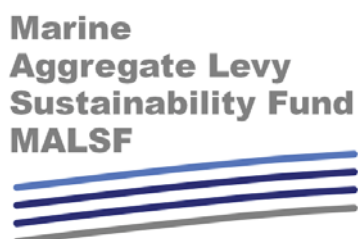

Administered by:



Supported by:



How the wreck was found

Though systematic searches for shipwrecks do take place for research or commercial purposes, many shipwrecks are discovered accidentally and this was the case with the wreck that has become known as the Mystery Wreck. In 2003 a fisherman, fishing for sole and plaice in a 7m long fishing trawler, snagged his nets on a seabed obstruction. Seabed obstructions can be a real problem for the fishing industry, causing damage or complete loss when nets are snagged. Initial discoveries of wreck sites are often made by fishermen in this way.



The net snag was reported to the Hampshire & Wight Trust for Maritime Archaeology (HWTMA).

Each year, HWTMA runs a project called SoIMAP, which involves divers, volunteers and students researching and studying historic sites on the seabed of the Solent and in 2003/4 a team of divers was sent to investigate the location of the net-s snag and found the remains of a timber-built ship.

The Marine Environment: Life and Work in our Seas

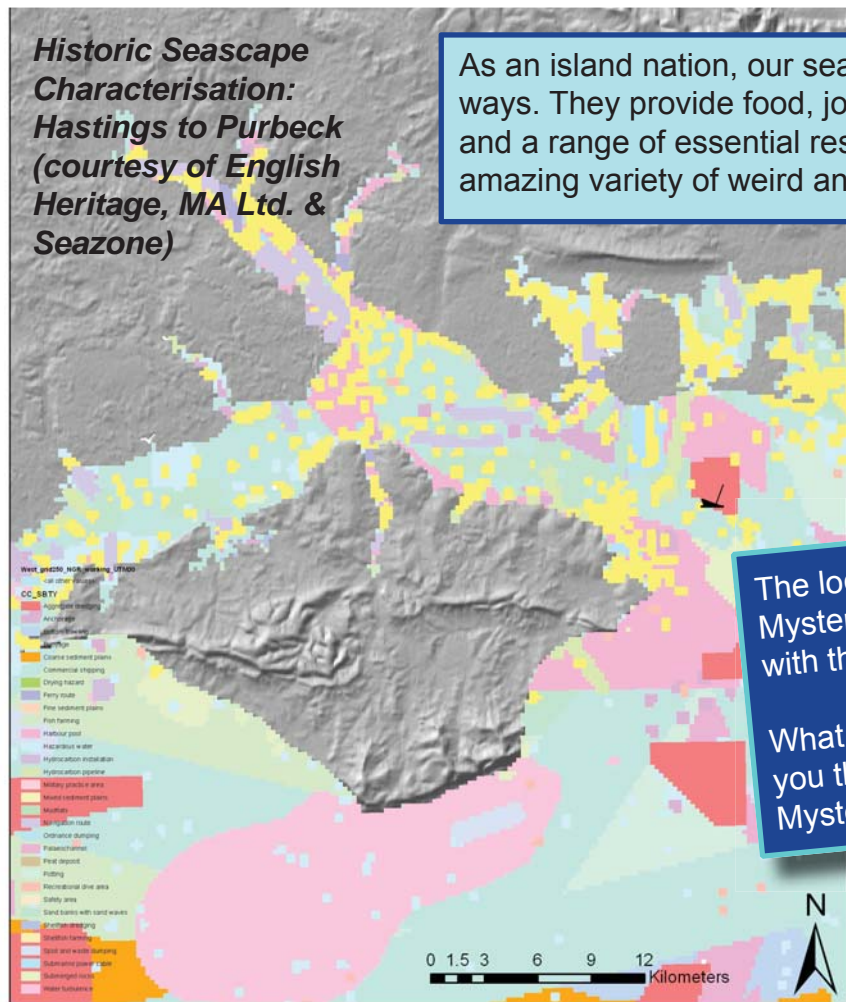

As an island nation, our seas are very important in many ways. They provide food, jobs, energy, leisure/sporting venues and a range of essential resources. They are also home to an amazing variety of weird and wonderful species.

This map has been created using a Geographical Information System (GIS: page 6). It shows the many, varied and often conflicting pressures on the marine environment.

The location of the Mystery Wreck is shown with the 'wreck' icon.

What activities in the marine zone do you think might have an impact on the Mystery Wreck?

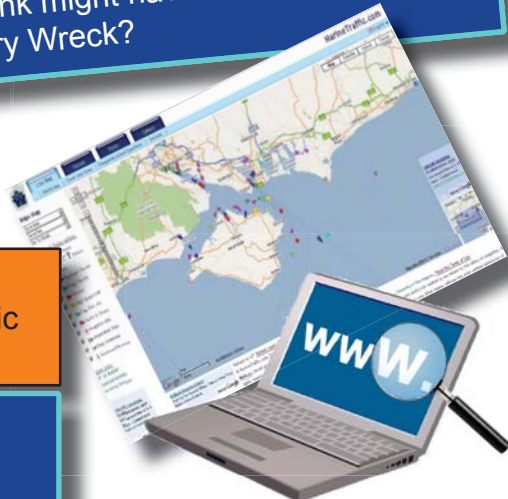

See the amount and type of maritime traffic that crosses the Mystery Wreck site today by looking at the live maritime traffic website at: www.marinetraffic.com

HINT: Using dropdown box for 'Go to Port...' select [UK] Portsmouth. Zoom out and pan around map.

Building materials from under the sea

You might be surprised to learn that we use around 200 million tons of sand and gravel every year in the UK. The sand and gravel is called aggregate and is used for building roads, houses, schools, power stations, shopping centres, football stadiums, airports, railways and supporting clean water, drainage and waste facilities.

Aggregate can be extracted from land quarries or from marine deposits under the sea.

How did it get there?

Before the end of the most recent ice age (the Devensian glaciation) Britain was joined to continental Europe and almost entirely covered by an enormous ice sheet. Sea levels were approximately 100 metres lower than they are today and the English Channel was a vast expanse of low-lying ground, riddled with fast-flowing rivers and inhabited by animals such as woolly mammoths. The rivers contained sand and gravel.

About 8,000 years ago, the ice began to melt and sea levels rose, creating the English Channel and the Solent. The ancient river valleys where our ancestors used to live, became submerged and today are called 'Palaeochannels'.

Extracting marine aggregate

Marine aggregate is extracted from the palaeochannels on the seabed using dredgers. About 21% of the sand and gravel needed in England and Wales, is extracted from the sea.

*An aggregate dredger in action.
Animated version and further information at:
http://www.bmapa.org/what_dredge01.php#*

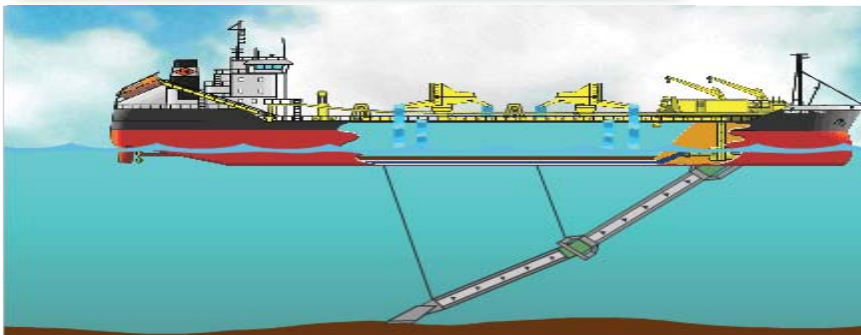

Did you know that every person in the UK (that includes you!) generates an indirect need for over 4 tonnes of construction aggregate each year!



A V-shaped cross-section of a palaeochannel can be clearly seen in this eroding cliff face

Find out about land quarries at:
www.virtualquarry.co.uk/



RECYCLING
Demolition of old buildings and resurfacing of roads produces large volumes of construction waste. In the past this waste was sent to landfill but increasingly it is being reprocessed and recycled to provide aggregates. Over 25% of all the aggregate we use in the UK comes from recycled or secondary aggregates.

Dredgers bring marine aggregate back to wharfs where it is cleaned, sorted and transported to where it is needed.

Using the information in this booklet and online research, write a list of advantages and disadvantages for extracting aggregate from land quarries and marine sites.

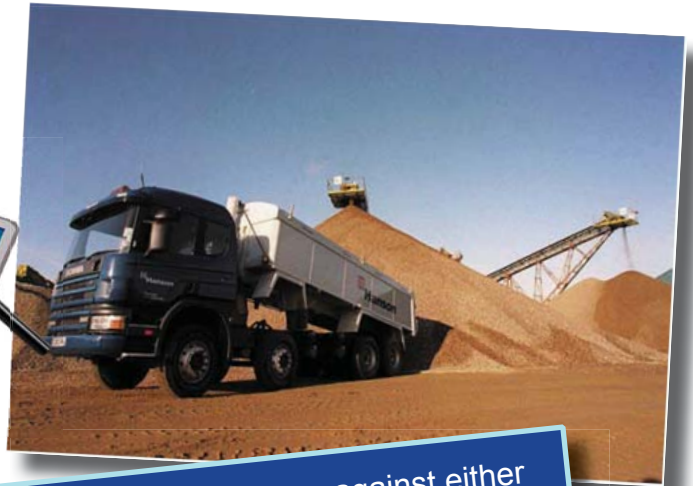

Produce a poster or advert to campaign for or against either form of aggregate extraction.

Working together for sustainability

Archaeologists are interested in palaeochannels because they contain clues about how our ancestors survived and the environment in which they lived.

Marine Biologists are interested in palaeochannels because they create a unique habitat favoured by certain marine species.



While primarily concerned with their own priorities and aims, all professions and industries must find a way to work alongside or in partnership with other industries and professions.

Palaeochannels are also important because they provide sand and gravel vital for the construction of roads and buildings.



This is especially true in the marine environment where all resources are limited, fragile and often non-renewable. The case studies in this booklet show how different industries work alongside each other and collaborate to work together.

What do you think potential conflicts of interest could be between archaeologists, marine biologists and the aggregate industry when working in the marine environment?



Do some research at:
www.bmapa.org/issues.php

Control, licensing & protecting the environment

Companies selling sand and gravel extracted from land quarries or UK waters must pay a tax (Aggregate Levy) to the UK government.

What do you think the benefits of such a tax could be?

A proportion of the Aggregate Levy has been used to fund research to help balance the environmental costs associated with aggregate extraction. The fund is called the Aggregates Levy Sustainability Fund (ALSF).

Marine aggregate can only be extracted from the seabed in certain licenced areas around the UK's coast.

The Mystery Wreck lies within a licenced marine aggregate extraction area, so when the wreck was discovered, an **Exclusion Zone** was established around the site. This protected the site by preventing further dredging and HWTMA applied to the Aggregates Levy Sustainability Fund for funding to support further research into the Mystery Wreck.

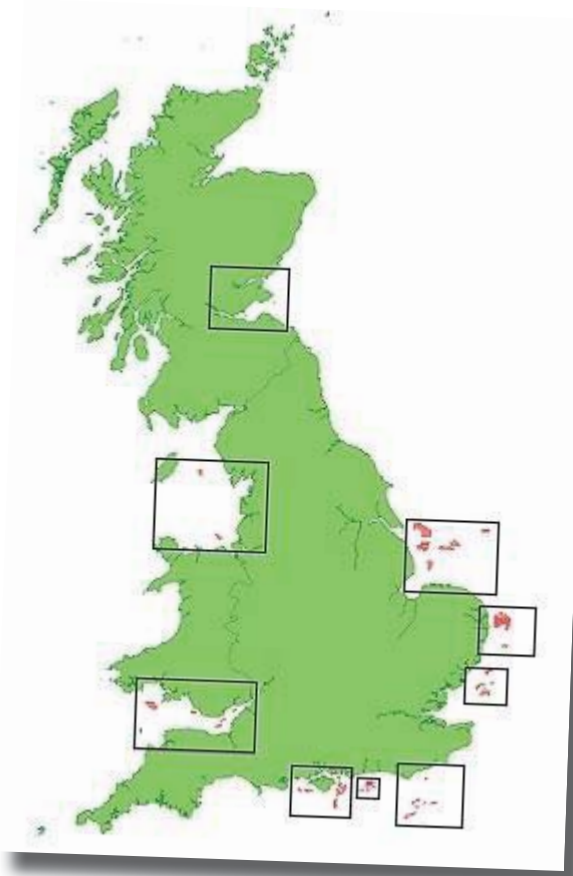

Areas licensed for aggregate extraction in the UK



Mystery Wreck in relation to licenced marine aggregate dredging zones.

Exclusion Zones
 A defined zone within a dredging licence where extraction is excluded to protect archaeological or natural features – including wrecks.

To learn more about the science behind aggregate area Exclusion Zones search the internet for:
 Archaeological Data Service
 Exclusion Zones



Gravel treasures

Now you know about palaeochannels, you've probably already worked out that sand and gravel on the seabed could contain material dating back more than 500,000 years. Such material can provide valuable information about how our ancestors lived.

The consenting authority for marine mineral extraction is the Marine Management Organisation (MMO). They issue commercial licences enabling the holder to dredge for marine aggregates.

Before a licence is granted, an Environmental Impact Assessment (EIA) must be undertaken. An EIA must describe the project and any significant effects it might have on the environment.

What aspects of the environment can you think of that might be affected by dredging marine aggregate from the seabed?

Although the EIA process assesses proposed dredging areas for archaeological potential prior to the granting of a licence, dredging industry staff are still likely to come across archaeological finds during their day-to-day work. Since 2005 an awareness programme and Protocol to encourage the reporting of archaeological artefacts found during marine aggregate dredging work has been in place. This helps protect our submerged heritage by highlighting and cataloguing these accidental finds.

Some of the accidental finds from marine aggregate reported through the protocol. What do you think they are?



Images © Wessex Archaeology

Template available at www.hwtma.org.uk/mwtpdownloads



Tools of the Trade: GIS

In many different professions it is necessary to look at a geographical area to see for example, how it is being used, how it was used in the past, how things relate to each other in space, the nature and extent of natural and built features etc.

A Geographical Information System (GIS) is a computer based tool that enables people to view, question and draw conclusions more easily from maps and datasets.

A dataset comprises georeferenced points, areas or lines. Georeferenced means they have a known location in space, i.e. geographical co-ordinates that can be plotted onto a map.

There are some excellent introductions to GIS on the internet:

Introduction to GIS: free online tutorial on the Harvard Map Collection website. The powerpoint presentation with audio lasts approximately 10 minutes and uses clear graphics and commentary to explain what GIS is, how it can be used and introduces some basic GIS terminology.



<http://hcl.harvard.edu/libraries/maps/gis/tutorials.cfm>
OR
Search for 'Harvard GIS Tutorial'



GIS Zone: freely accessible interactive website about GIS produced by Ordnance Survey. Includes TeacherZone with lesson plans and activity sheets.

<http://mapzone.ordnancesurvey.co.uk/mapzone/giszone.html>
OR
Search for 'Ordnance Survey GIS Zone'

You have probably already used a very simple Web-GIS platform such as Google Maps or Bing Maps. See page 8 for another example of a Web-GIS platform.

You can also download a free version of Google Earth which has more GIS features.

Here is a dataset of points, take a close look and see if you can guess what these points might be.

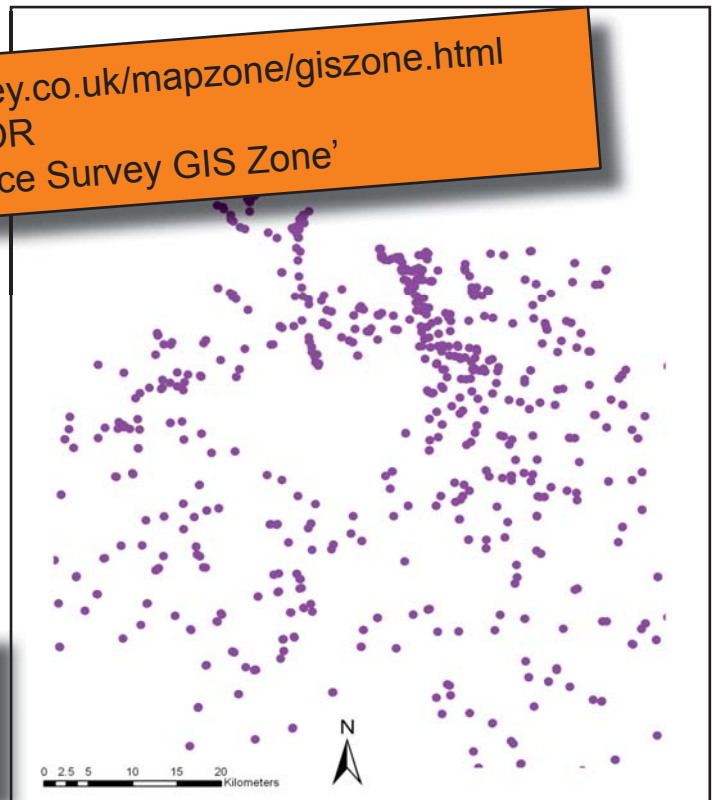

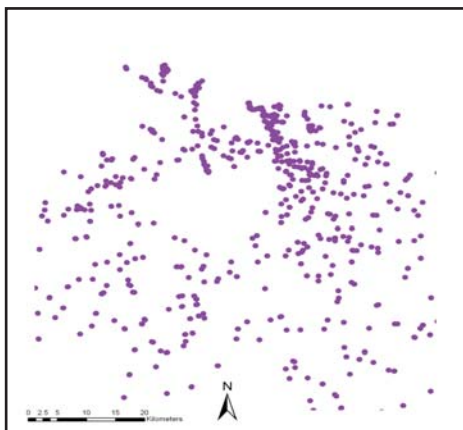

A GIS dataset is a layer of georeferenced points (or lines, or areas). Each layer of information can be turned on or off, depending on what the user is trying to do. For example, the scatter of purple dots from the previous page can be superimposed onto a base map to show the location of known shipwrecks around the Isle of Wight:

Archaeologists researching the Mystery Wreck use GIS in this way to compare the location of the Mystery Wreck on the seabed, to locations of known wrecks. This can help determine the identity of the wreck.

As part of their research, archaeologists will also look at different datasets to see how present day activities might affect the Mystery Wreck site.

The GIS generated image below shows areas where the seabed is used for cables (yellow) and oyster beds (red).

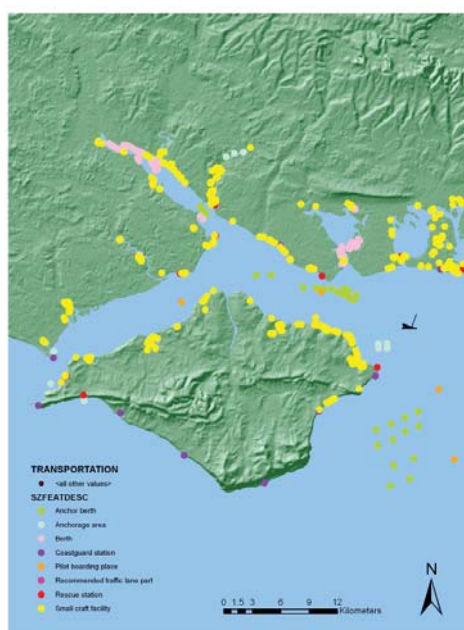
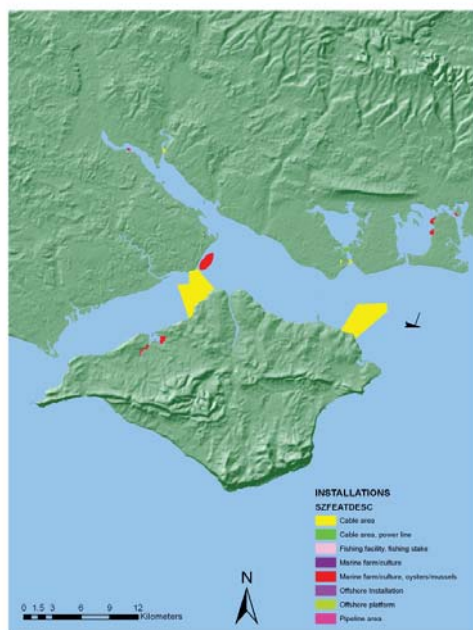
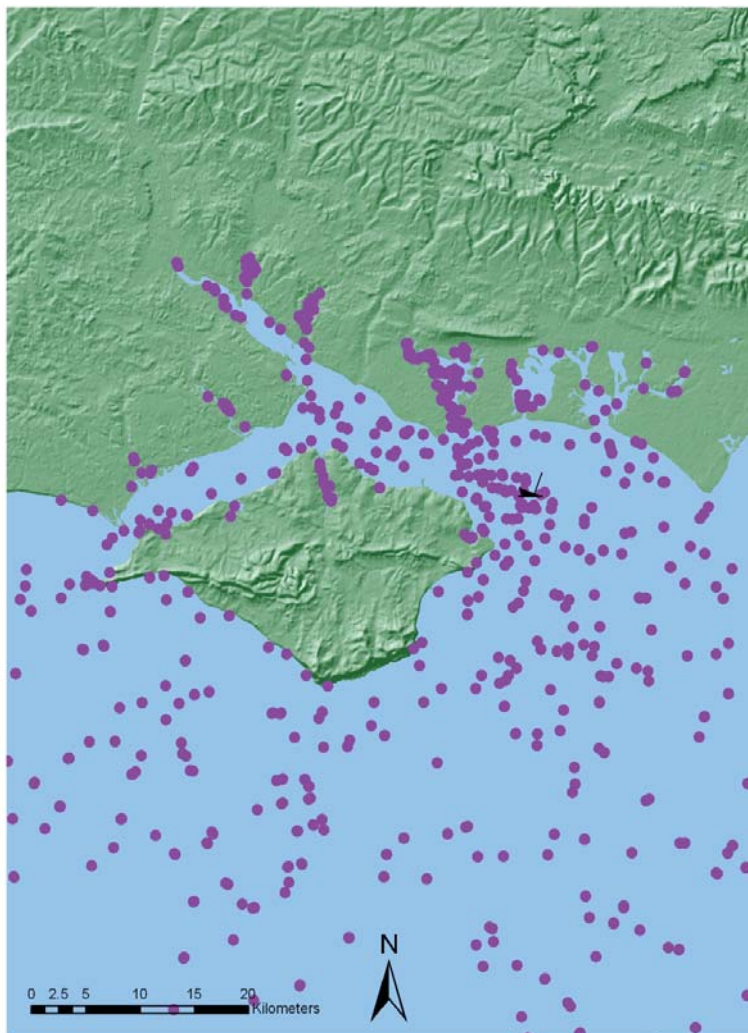

This image shows how the environment is used for transportation. The lime-green dots to the north west of the Mystery Wreck and the pale blue dots to the south west, show different types of anchorage areas for modern shipping.

GIS in practice

The Royal Navy's first *Invincible* was in fact a French ship that began life as *L'Invincible* in 1744. Following a calamitous series of events the 74-gun, two-deck warship ran aground and eventually sank, close to the location of the Mystery Wreck, in 1758. For 221 years HMS *Invincible* lay undiscovered embedded within Horse Tail sandbank until it was discovered in 1979, again by a fisherman snagging his nets.

The *Invincible* has been excavated and researched for over 20 years and the results of this work have been collated and presented in a digital archive that can be explored online at: <http://www.hwtma.org.uk:8008/mapguide/invincible/main.php>

The *Invincible* Digital Archive uses an Open Source web-based platform that works in the same way as a GIS. The base map, rather than being a geographical area like the Solent, is the site plan for the *Invincible* shipwreck.

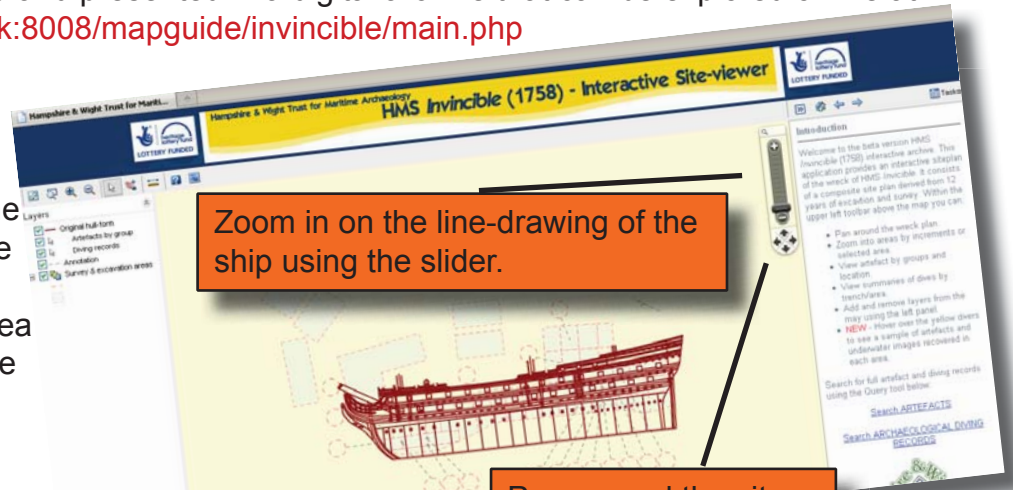

Zoom in on the line-drawing of the ship using the slider.

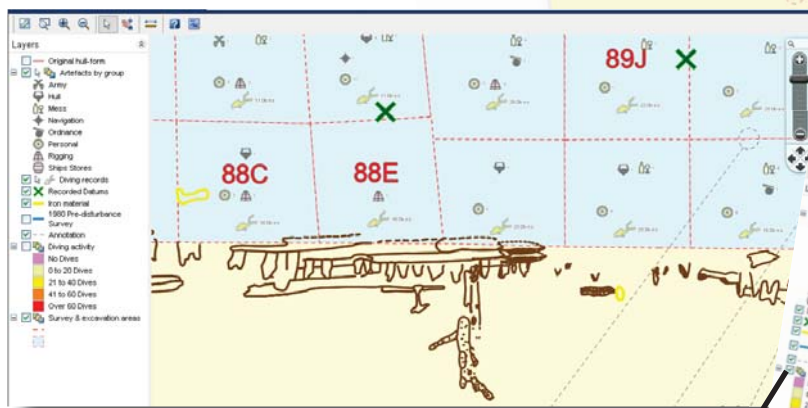

Pan around the site using the arrows.

Try turning layers on and off to see how you can look at different types of information.



Click on a yellow diver icon to see photos of some of the artefacts found on that part of the site.



Using the Digital Archive, can you answer the following questions:
How many dives took place in Survey & Excavation Area 90Z?
How many ordnance artefacts were found in Area 88K?
Try devising some of your own questions.

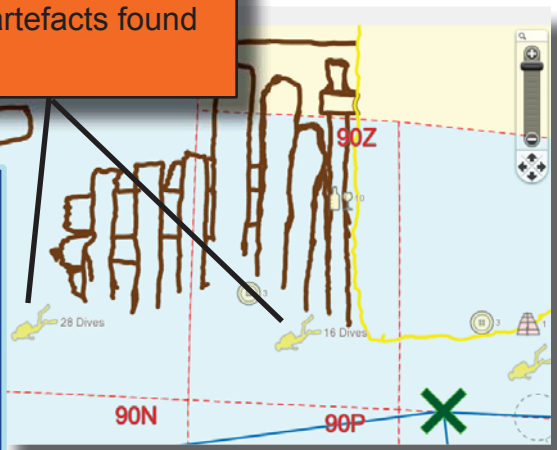

ICT

HISTORY (Interpretation)

GEOGRAPHY (Key Processes: GIS)

Tools of the Trade: Geophysical Survey

Disciplines and industries working in the marine environment often need to understand the nature of the seabed. The seabed is characterised in terms of sediment, texture and morphology (shape and structure). A range of marine geophysical survey tools are used to 'picture' the seabed. The following are acoustic (sound) systems.

Side Scan

A side scan sonar sends a fan of sound down to the seabed. When the pulses are returned from the seabed (this is called the 'echo') a side scan sonar calculates the strength of the echo. The strength of the echo depends on the material properties and shape of the seabed and anything lying on it. Rock, gravel, wood and metals reflect stronger signals than sand and silt and are therefore recorded as higher intensity areas on the sonar image.



Search for 'side scan sonar shipwreck' to see some amazing side scan images. Look out for the acoustic shadows.



Acoustic Shadows

Acoustic shadows occur alongside objects that stand proud of the seabed. They can provide important information about the shape and nature of a target.

Typically, a side scan sonar is mounted within a towfish which is towed behind a survey vessel. In the photo to the right a side scan sonar is deployed from a survey vessel. It will trail behind the boat at a distance related to the depth of water and speed of the survey boat.

Photo: Kongsberg/GeoAcoustics



Multibeam swath systems

A multibeam swath system emits a swath of acoustic (sound) pulses in the form of a thin strip, below and to the side of a survey boat and repeats at up to 50 times a second as the boat moves forward.

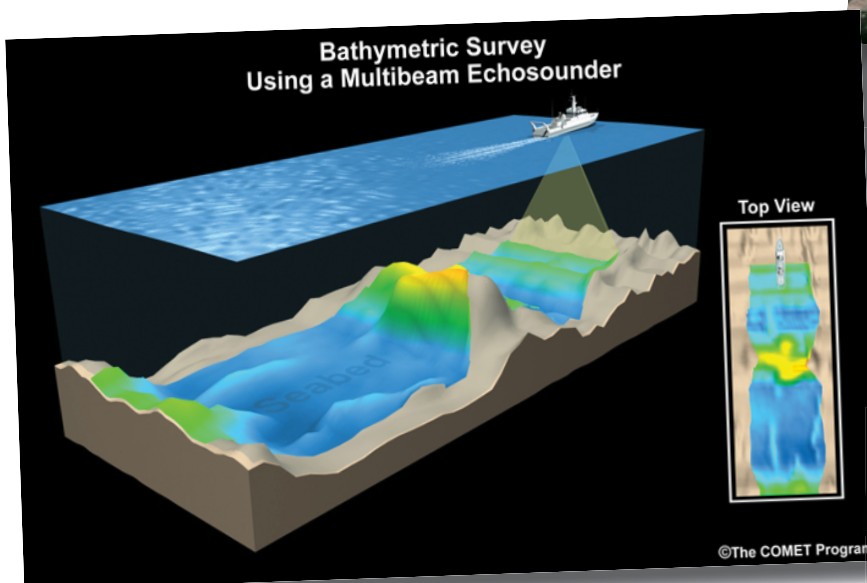

The pulses are returned from the seabed to the swath system providing information about the depth (**bathymetry**) of the seabed.

Bathymetry

Measurement of depth in water.

Marine Geophysics: Picturing the Seabed

The depth data collected in a multibeam swath bathymetry survey can be presented in a variety of ways.

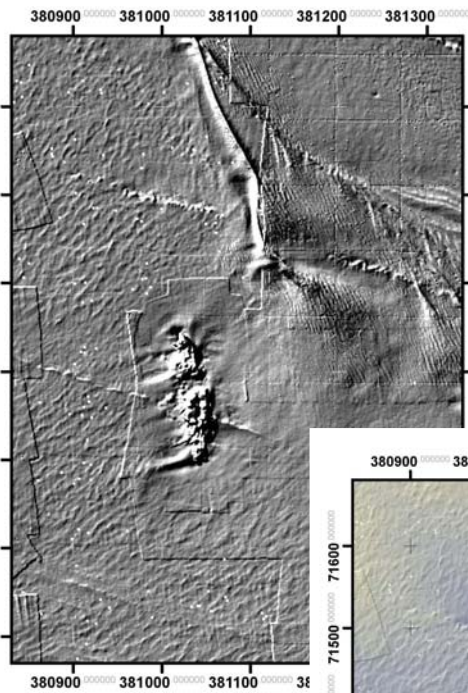

For example, a 'hillshade' or 'shaded relief' image uses a lighting effect to represent elevation variations (differences in height/depth) on the seabed.

The 3-dimensional nature of this underwater site is represented by areas of light and shadow.

A sandbank can be seen (top right) with some kind of non-natural feature below and to the left of it.

By overlaying this hillshade image with a semi-transparent colour-coded bathymetry image (where different colours represent different depths) the nature of the site becomes more apparent.

Another way to view the bathymetry data is to undertake a 'slope analysis' which reveals the maximum slope angles on the seabed. This is particularly effective for picking out anything that stands proud of the seabed.

Can you see the shipwreck on the seabed?

The wreck that can be seen in these images lies off the coast of Portland, Dorset, UK. The ship was called the *Alex van Opstal*.

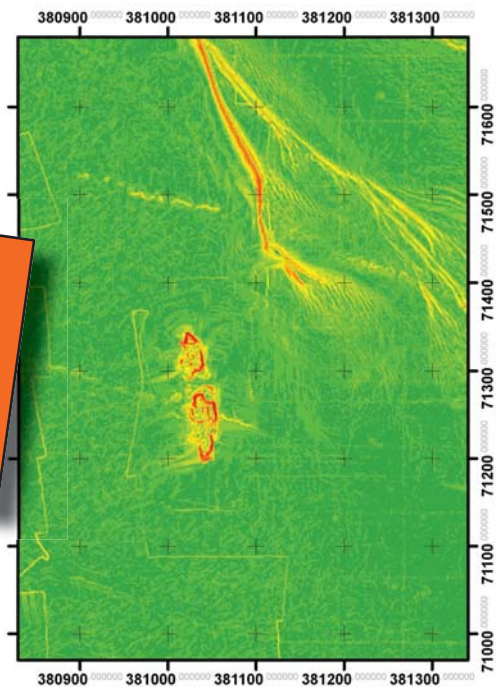
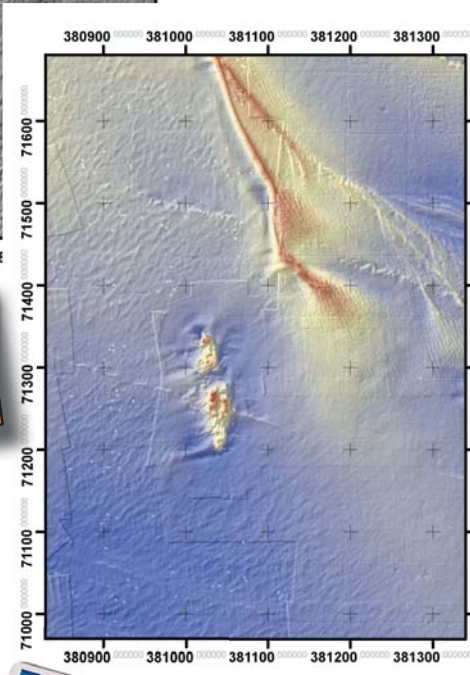

These images were produced using data from DORIS (DORset Integrated Seabed survey). See acknowledgements page 39.



Search the internet for 'Alex van Opstal wreck' to find out about the ship and its significance to World War II.

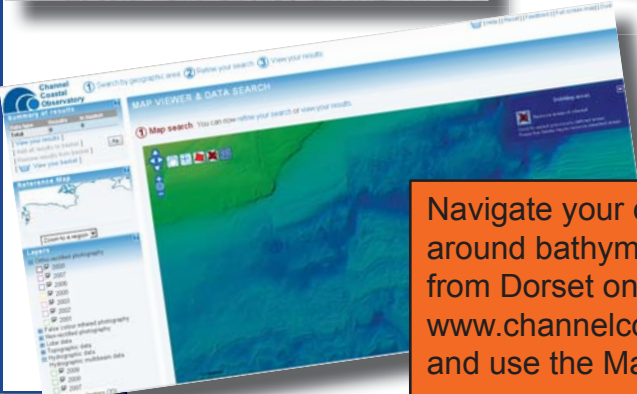

Navigate your own way around bathymetric data from Dorset online at: www.channelcoast.org/ and use the Map Viewer.

As you will see, the Channel Coastal Observatory data is available in the form of an online GIS. To see the bathymetric data, make sure the Hydrographic (multibeam) data 2008 layer is selected and zoom in.



There is a shipwreck on the seabed south of Durlston Point (south of Swanage, Dorset). Use an online map and the Channel Coastal Observatory website to help you find the wreck.

Find out about the wreck and how it relates to WWI by searching for 'Kyarra Dorset'

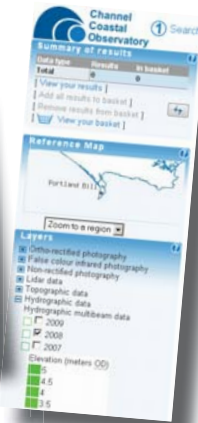

Archaeological Case Study

Fieldwork: Shipwreck Survey

Archaeology is often associated with excavation but excavation is usually a last resort for an archaeological site because the process is extremely costly and completely irreversible. When first looking at a site, archaeologists will want to carry out an archaeological survey which aims to produce an accurate picture of a site in the form of a two-dimensional site plan on paper and/or a computer.

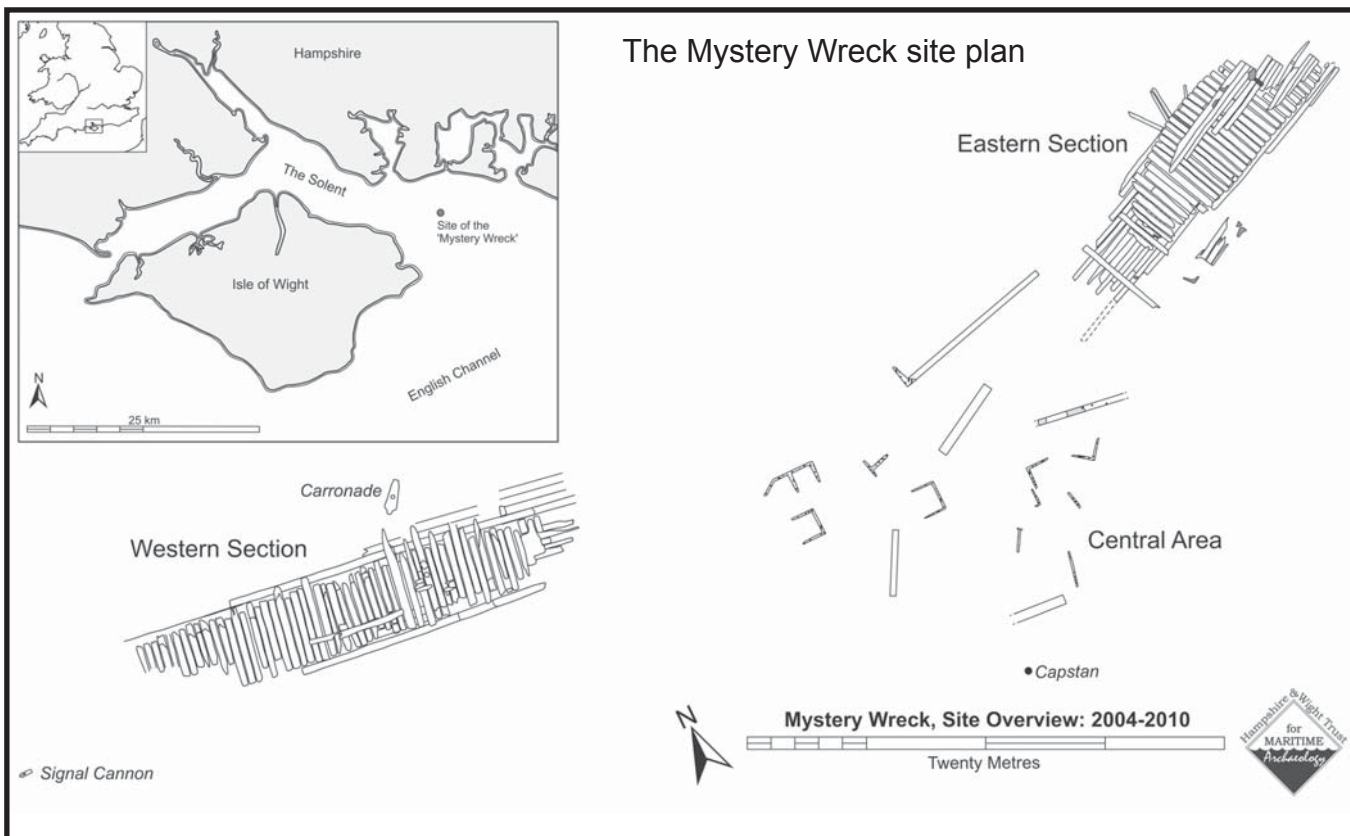

It is important that a site plan shows the geographical location of the site, the orientation, the date when the data were collected and a scale.

The Mystery Wreck site plan was produced from information collected by pairs of divers using SCUBA equipment, a drawing board and a measuring tape.

Typically a dive lasts approximately an hour and it might be possible to undertake two dives in one day. In practice, weather and limited resources means that in an average year, approximately 4 – 10 days might be spent diving on a site in the UK.





During the course of a dive, a pair of divers can collect anything from 1 – 30 measurements and associated sketches. Other underwater tasks include photography, video and retrieval of samples and (where appropriate) artefacts. The Mystery Wreck site plan consolidates measurements, sketches and plans collected by divers over seven seasons.



HWTMA UNDERWATER SURVEY RECORD SHEET

Name: HWTMA
 SLT: STEVE + GAIL Date: 18/6/09 Number: 25
 Survey sites: Mystery Wreck Access: the ground Continuity from: _____
 Equipment: Swatch - 2m, tape, video Time in: _____ Time out: _____
 LW drawing ref: _____
 Page: 2 of 2

Datum/Reference point	Isol depth	Distance	Comments	View ref	Vis
H 99	H 43	3.15			2 1/2 m
H 99	H 47	5.35			
H 99	H 71				

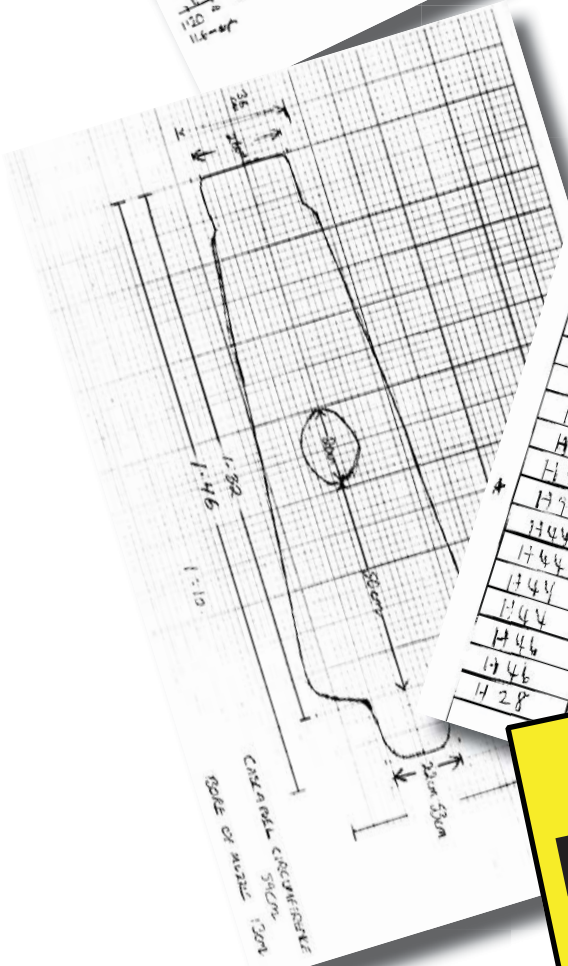

Yellow tags, like the one below, each with a unique letter/number identifier are secured to the Mystery Wreck timbers. Measurements are taken between these points which helps build up the site survey. They're also helpful for navigating around the site. Look out for them during the virtual dive (page 13).



Virtual Dives

Visit the HWTMA website to undertake a Virtual Dive on the Mystery Wreck.

See what the divers see as they swim over the wreck site at a depth of approximately 10 metres. Get a feel for the visibility, physical and logistical limitations and opportunities and spot a variety of marine species that have made the Mystery Wreck their home.



www.hwtma.org.uk/mwtpvideo



Download the Mystery Wreck Site Plan showing the track over the site that the videoing diver took:
www.hwtma.org.uk/mwtpdownloads

Download and complete a Video Dive Log for the Virtual Dive.

Plot the divers' progress over the site on the site plan.

Video Log Sheet			Page	of
Title			Video no.	
Site			Data Sheet no.	
Location				
Date				
Subject	Description			
Time: Counter				
From	To			

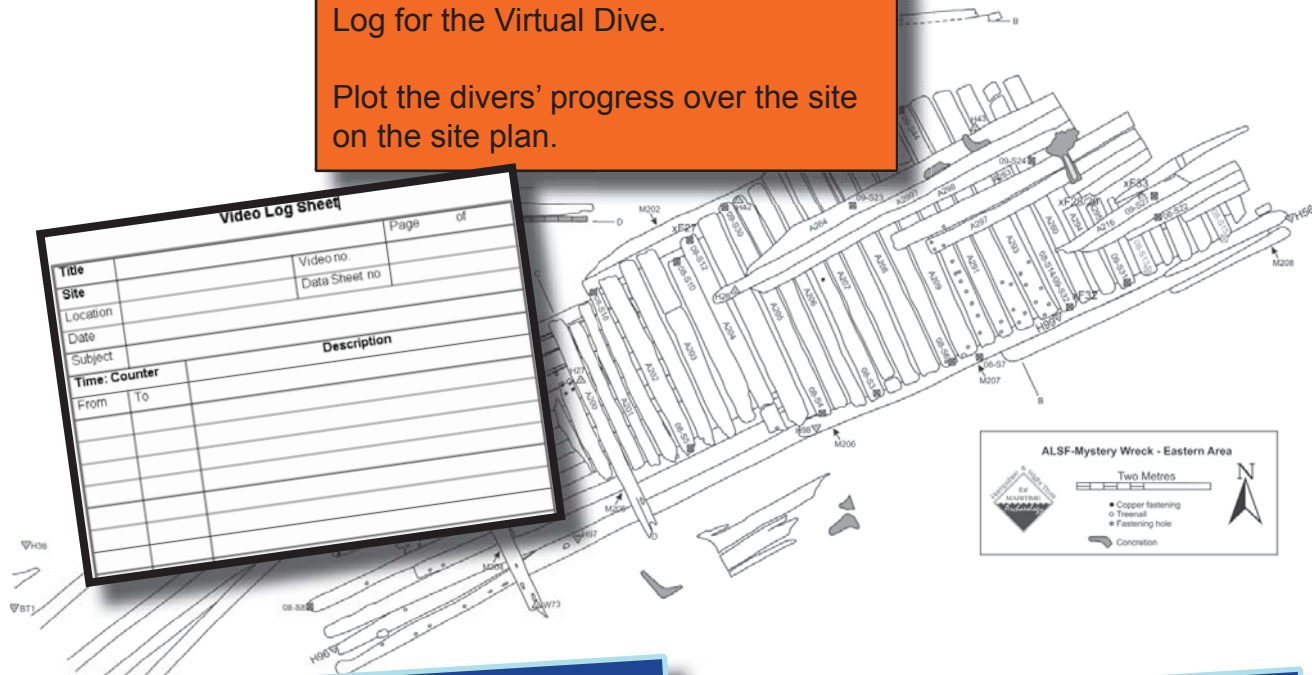

What direction does the diver with the video camera initially travel in?

What material was the Mystery Wreck built from?

Create a piece of creative writing from the perspective of either: the diver, a creature living on the wreck site, the Mystery Wreck itself.

Shared Seas: International Collaboration

When studying shipwrecks, archaeologists from different countries can benefit enormously from each others' knowledge and experience.

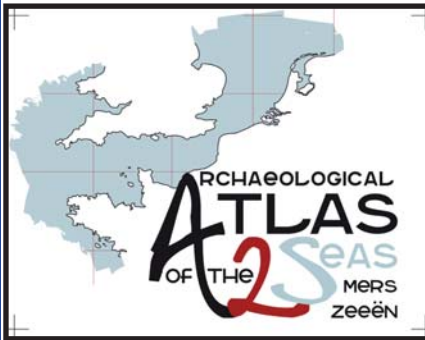

Why should the study of shipwrecks benefit from international archaeologists working together?

The global nature of shipping makes international collaboration between maritime archaeologists extremely important. An example of how this can work in practice is the **Archaeological Atlas of the 2 Seas** (A2S) project, which involves archaeologists, students and volunteers from England, France and Belgium working together to research, investigate, survey and promote underwater sites within the southern North Sea and the English Channel.

A2S Project partners: HWTMA, the Association for the Development of Maritime Archaeological Research (ADRAMAR), the Flemish Heritage Institute (VIOE)

As part of the project a European team of divers has been working on sites off the south of the Isle of Wight, such as *SS Coquetdale* which lies in 40 metres of water. *Coquetdale* was one of four British vessels sunk by Luftwaffe dive bombers on the 8th August 1940. This attack heralded the beginning of the Battle of Britain.



An international team gathered for an underwater survey project in France.

The *Smyrna* is a wool clipper that collided with another ship in thick fog while en route from England to Sydney, Australia in 1888. A hole was torn in the side of the ship and it sank with the loss of 12 lives. It now lies amazingly preserved in 50m of water to the south of the Isle of Wight.

The A2S team have also been investigating shipwrecks elsewhere in the English Channel and southern North Sea. Find out more at:
<http://www.atlas2seas.eu/>



Assessing the Evidence

Measurements, photographs, video, samples and artefacts collected from the Mystery Wreck over 6 years have provided a number of clues that can help archaeologists discover the ship's identity. You can take the role of a maritime archaeologist and work through these in the following pages.

Clue 1

The Mystery Wreck was built of wood and no evidence has been found for any engines, boilers or other machinery on the site.



The timber remains and lack of boilers, engine parts and associated machinery suggests that the Mystery Wreck was a wooden sailing ship.

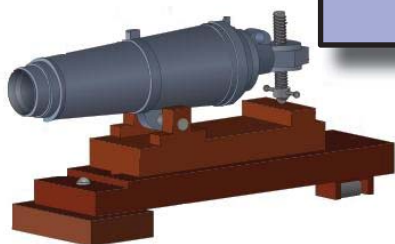

Two guns have been identified on site, a small signal cannon and a carronade.

Clue 2

The Mystery Wreck carronade

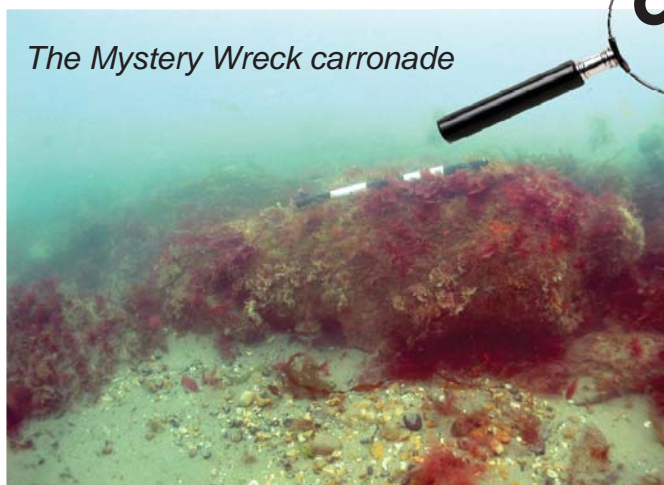

A Carronade is a short cast iron cannon invented in the 1770s.

A Signal Cannon, as the name suggests, is a small gun used for sounding signals. Until relatively recently, all ships would have had one, so we can't learn much from its presence on the Mystery Wreck.

As only two guns have been found on the Mystery Wreck it is unlikely that it was a fighting ship, however...

Guns

As with most aspects of archaeology, we must consider the facts carefully. Guns were very valuable and were often salvaged from a shipwreck and re-used or recycled, so the absence of guns on a site does not necessarily mean the ship wasn't originally carrying them.

Guns are often inscribed with dates and even when these are concealed by marine growth or rust the shape and dimensions of a gun can help determine a date and provenance for a ship or wreck. Unfortunately this has not been the case with the Mystery Wreck (so far at least).

Clue 3

By measuring individual timbers and producing an overall site plan, it is possible to work out that the Mystery Wreck was a ship at least 30m long when intact.

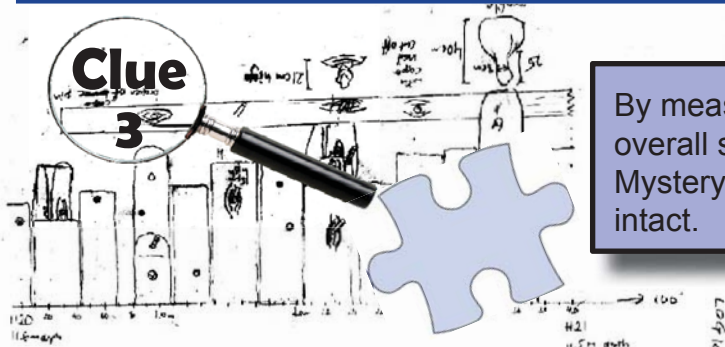

The ship has been built with the use of both tree nails and copper (or copper alloy) pins or bolts.

**Clue
4**

Ship fastenings

The way a ship was built, including the type of bolts and nails used to hold it together, can provide clues about when and where it was built. Treenails are tight-fitting wooden pegs, driven through planks and frames to fasten them together. They have been used in shipbuilding since ancient times and their presence (or absence) does not necessarily provide an easy indication of date or provenance (where the ship came from). By looking at other shipwrecks, for which dates are known, we can determine when copper/copper alloy bolts were used. For example, in the Solent, not far from the Mystery Wreck lies the wreck of *Warship Hazardous*, built in 1698 and lost in 1706. There is no evidence for copper bolts on *Hazardous*. *HMS Impregnable*, also close to the Mystery Wreck was launched in 1786 and wrecked in 1799. By this time copper bolts are widely used and are very common on the *Impregnable* site.

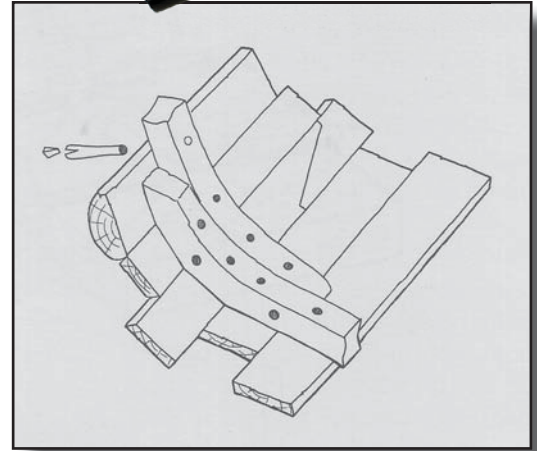

What advantages do you think treenails might have over metal fastenings?

The use of copper/alloy bolts in the construction of the Mystery Wreck suggests it was built after the end of the 17th century.

**Clue
5**

Significant amounts of a material that looks like coal, coke or slag have been found between the ship's timbers and across the site.

Cargo / Ballast

The relatively large amounts of coal-like material found wedged between the frames of the Mystery Wreck suggests that it was being carried as a cargo. An alternative interpretation is that it was ballast but the light weight of the material suggests cargo is more likely than ballast.

The extent to which the material is wedged between timbers may mean that this was not the final cargo of the vessel, but it is likely to relate to the ship's function relatively close to the time of wrecking.



Ballast

Some type of heavy material is often carried in the bottom of ships. This lowers the centre of gravity and makes the ship more stable.

Sometimes that ballast is worthless at the time the ship is sailing but more often it is a material that can be offloaded and sold at the destination. In this way it serves as both ballast and cargo.

Clue
6

Iron knees which were used in the construction of the Mystery Wreck have been identified on the site.

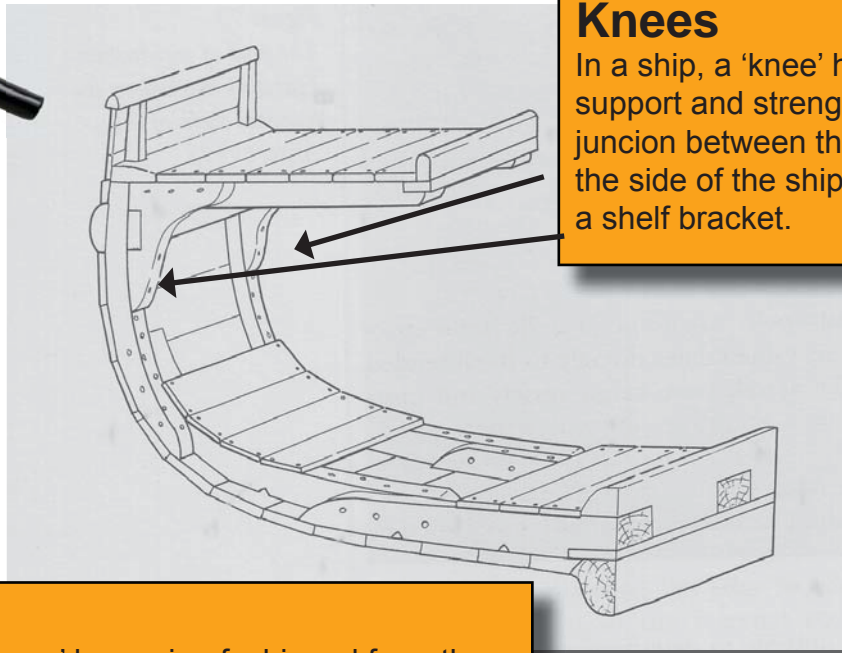

Knees

In a ship, a 'knee' helps support and strengthen the junction between the deck and the side of the ship, a bit like a shelf bracket.

Knees

Earlier ships have 'grown' knees i.e. fashioned from the part of a tree where a branch joined the tree trunk.

Later ships had knees 'cut' from straight timbers or formed by joining two or more peices.

Looking at the type of knees on a ship can help determine a date for a ship.

Why do you think 'cut' knees became more common than 'grown' knees?

Iron knees

The Industrial Revolution of the 18th century heralded experimentation, initially in France, with using iron for knees in ships. When the British captured the french warship *L'Invincible* (see page X) in 1747, the ship's iron knees were one of a number of design features that were incorporated into subsequent British ship buiding methods and techniques. The presence of iron knees on a timber ship suggests a late 18th to late 19th century date.

What advantages do you think iron knees would have over timber knees?

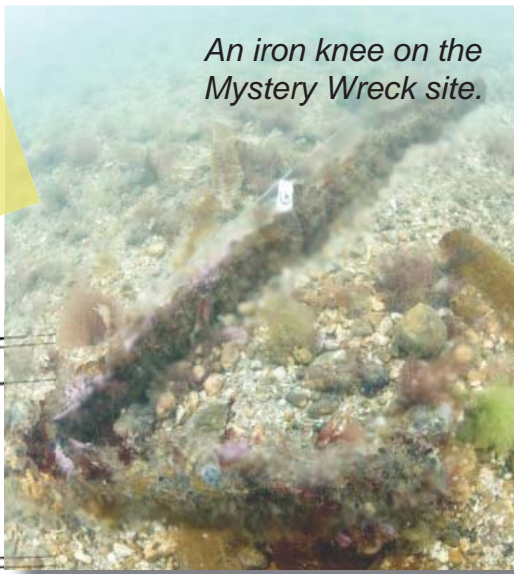

An iron knee on the Mystery Wreck site.

Clue 7

A small number of artefacts have been found with the Mystery Wreck.

Artefact

An artefact is anything that has been made or altered by a person.

Use the artefact photographs and Finds Record Log below to identify the Mystery Wreck artefacts.

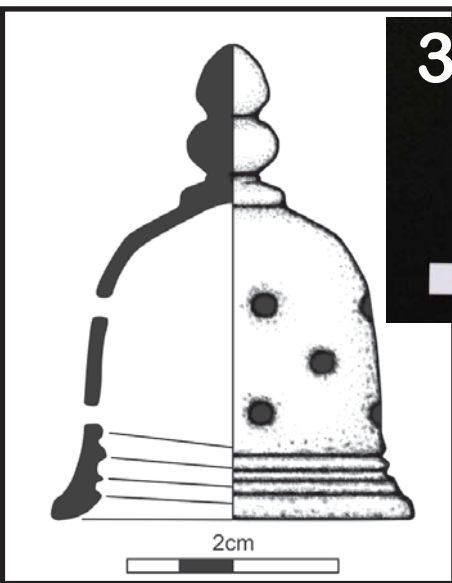

Year	No.	Material	Dimensions (LxB,W mm)	Desc./Notes
2009	24	Copper alloy	95 x 35	Copper/alloy sheathing
2009	25	Copper alloy	75 x 5 x 45	Rim of Hand Bell
2009	29	Slag/Coke		Peices of coke/slag
2009	33	Silver/Pewter	H 45, Diam. 38	Possible sugar-shaker top
2009	41	Copper alloy	200, Diam. 15-20, Head. Diam. 36	Copper bolt, bent.

Artefacts from shipwrecks can sometimes provide very obvious clues about when a ship sank, what it was doing and where it came from. However, many shipwrecks are like the Mystery Wreck, with only a few artefacts that don't tell us an awful lot unless we look VERY closely at them. In this way, archaeologists can squeeze every last clue from an artefact and site.

Wondering what a sugar-shaker looks like?
 1) Ask your grandparents
 2) Search online for 'muffineer'



Copper sheathing

In the mid 18th century the Royal Navy began experimenting with sheathing ships in thin sheets of copper. The first Royal Navy ship to be sheathed in this way was HMS *Alarm* in 1761. The copper sheathing created a physical barrier that prevented shipworm from reaching the ship's timbers. In addition, when in water the copper gradually degrades, leeching poisonous copper salts that prevent weed and barnacles from attaching themselves to the bottom of the hull.

The copper came in sheets, each measuring approximately 36 x 120 cm. Sheets were attached to the hull with a slight overlap and each sheet was held in place with approximately 80 copper tacks (small nails).

Every detail is important to an archaeologist. For example, the number and pattern of holes in copper sheathing sheets can help to date a ship!



Copper-alloy sheathing on hull of American clipper ship *Snow Squall* (1851-1864).
Image courtesy of Maine Maritime Museum.

However, copper sheathing resulted in an electrolytic reaction which led to the rapid deterioration of iron bolts holding a ship's hull together.

A thin layer comprising hair, yarn and brown paper ("Soft Stuff") was placed between the copper sheathing and the wooden hull to try and protect the iron bolts from the copper. In the case of the *Snow Squall* (left), analysis of the 'soft stuff' has shown it to be a bast fibre called jute (*Corchorus* sp.).

See what you can find out about 'jute'. What is a 'bast fibre'?

To understand more about why the copper sheathing caused the iron bolts to degrade, look up: 'Bimetallic corrosion' or 'Galvanic corrosion'.



In spite of the Soft Stuff, corrosion of the iron bolts holding ships together still occurred.

Industrial Revolution of the late 18th century

Many attempts were made to find an alternative metal for the bolts that held the ships together during the 18th century. Some were not strong enough, some too malleable or brittle and all were more expensive than iron bolts (not to mention the expense of removing iron bolts and replacing them with a new alternative). A suitable alloy for the replacement of iron bolts in shipbuilding wasn't found until the 19th century. Prior to that, the best solution was to strengthen copper by cold rolling it through grooved rolls, but controlling the process so that the metal did not become too brittle.

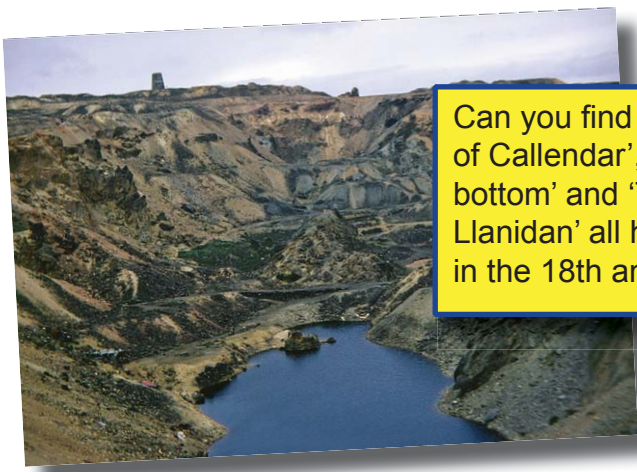

Can you find out what 'William Forbes of Callendar', 'Parys Mountain', 'Copper bottom' and 'Thomas Williams of Llanidan' all had to do with ship-building in the 18th and 19th centuries.



In 1708 the Royal Navy rejected the idea of copper sheathing for their ships, deciding that the amount of work involved and cost was too high. What do you think made them change their mind towards the end of the 18th century?

The attempt to protect ships' hulls from marine organisms has been a long process involving many inventions (many of which we don't have space to cover here). Often, practical, political, environmental and financial factors affect which inventions succeed.

What are some important questions to consider when deciding if an invention is successful or not?

Modern boats and ships are often made of metal or fiberglass, this prevents burrowing organisms but attaching plants and animals can still be a problem.

These days paints containing poisons are used on the ship hulls, some paints still contain copper, often combining it with herbicides to prevent seaweed growth. Some of these paints can be very toxic.



Search for 'TBT antifoul' to see how inventions are still being tested and rejected today.

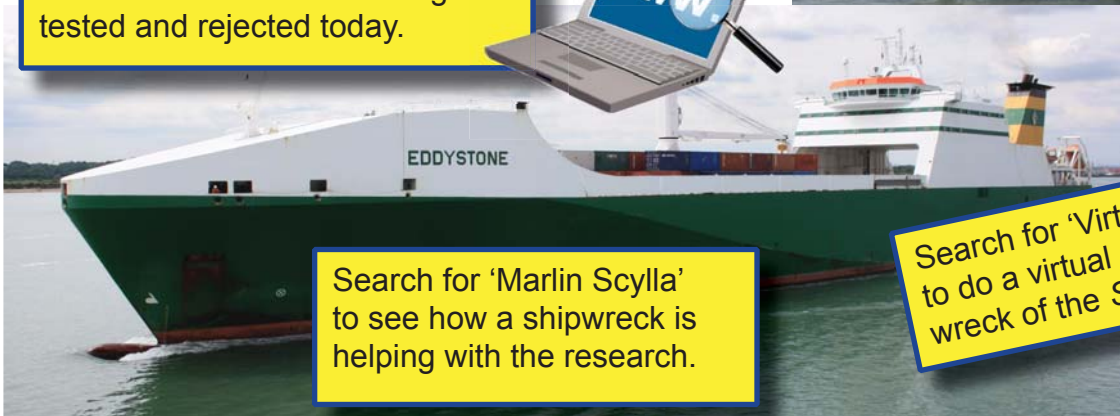

Search for 'Marlin Scylla' to see how a shipwreck is helping with the research.

Search for 'Virtual Scylla' to do a virtual dive on the wreck of the Scylla.



Back to the clues: Copper/Alloys

What does this information about copper/alloy sheathing tell us about the Mystery Wreck?

If the first Royal Navy ship to be copper sheathed was in 1761, the Mystery Wreck (also copper sheathed) must have been sheathed some time after 1761. This uses the concept of 'relative dating'.

Terminus post quem

Terminus post quem is Latin for 'limit from which' – it means the earliest time that something could have happened.

For example, in 1962 the remains of a ship were discovered in the River Thames, off Blackfriars in the City of London. When the ship was excavated a worn bronze coin was found underneath the base of the mast. The date on the coin showed that it had been minted in Rome in AD 88-89. This provided a *terminus post quem* for the Blackfriars Ship. The mast must have been put in place after AD89.

Relative Dating is a concept that archaeologists have adopted from geologists. It doesn't give a specific date for an artefact or event, instead it indicates whether something came 'before' or 'after' something else. See also **Absolute Dating** on Page 24.

What is our current *terminus post quem* for the Mystery Wreck?

Of course, each new clue can affect our *terminus post quem* but any new evidence can only alter the *terminus post quem* in one direction. In which direction can it go?

Here is an artefact photograph of a piece of copper sheathing from the Mystery Wreck. It was taken as soon as possible after the artefact was recovered. Note how important it is to have a scale (so you can tell the size of the object). Also vital is the information on the white card indicating the name of the site, the unique artefact number and a brief description.

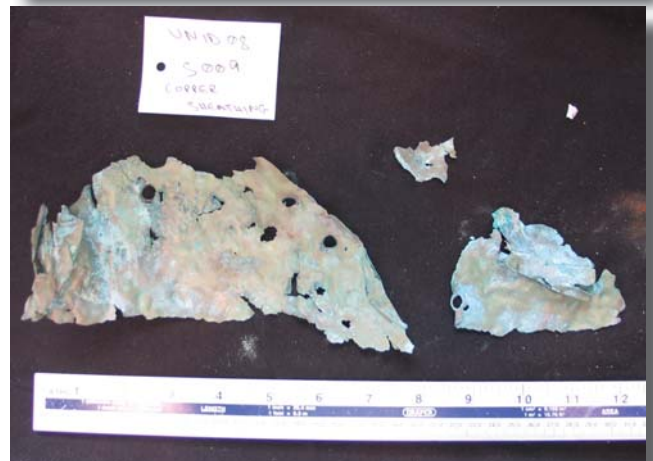

A closer look at the metal artefacts from the Mystery Wreck can tell us much more, so they were sent to a **metallurgist** for specialist analysis. The metallurgist looks at the **Composition** and **Microstructure** of the metal samples.

A Metallurgist:
studies the structure and properties of metals.

Composition: the separate elements that together constitute the metal.

Microstructure: the structure as observed through a microscope.

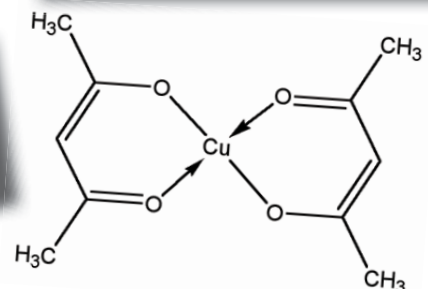

Here comes the Science!

An Electron Probe Micro-Analyser (EPMA) was used to study the **microstructure** of the alloy samples from the Mystery Wreck. An EPMA is a type of electron microscope with a **spectrometer** attached. A sample is first mounted in resin, then ground and polished using a spray of water containing tiny diamond particles (only one thousandth of a mm thick: 1 μm !). The EPMA then bombards the sample with a beam of high-energy electrons. Each individual element within the sample emits a characteristic X-ray. The X-rays are detected by the spectrometer, enabling the identification of each individual element within the sample. In this way it is possible to find out exactly what type of metal has been found. The discoveries don't end here however. Everything that happens to metal from the moment it is cast (hammering, heating, bending etc.) leaves a trace that can be seen by looking at the metal's microstructure.



Spectrometer:
an instrument used to measure properties of light

Charting Success:

50 ships were sheathed with Muntz Metal in 1837, 100 in 1838, doubling in 1840 and doubling again by 1844.

Can you show the increasing popularity of Muntz Metal for sheathing ships on a chart?

The metallurgist's report on the Mystery Wreck samples revealed that the sheathing was not in fact copper, it was an alloy of copper and approximately 35-37% zinc.

Over time, brasses can suffer from dezincification, which means that the amount of zinc found in brass is always lower than it would originally have been.

Muntz Metal (Yellow Metal)
In 1832 George Frederick Muntz, a metal roller from Birmingham, patented a new type of brass sheathing which was made up of 60% copper and 40% zinc. It became known as Muntz Metal or Yellow Metal and protected ships' hulls in the same way as copper sheathing. It had a great advantage over copper, however, in that it cost considerably less. While Muntz patented his new metal in 1832, production didn't start until some time later. Muntz's patent lasted until 1846.

For this reason, we would expect the amount of zinc actually present in 19th century Muntz-type Metal to be a bit lower than the 40% it would originally have been.

The Mystery Wreck zinc levels of 35 - 37% suggest an original zinc content of 38%. While this is close to the 40% zinc content typical of Muntz Metal the 2% difference could be significant. Muntz's patent specified a 40% zinc content. When the patent ran out in 1846, other manufacturers produced their own version of Muntz-type metal with slightly different zinc levels to Muntz's patent. For this reason, the metallurgist suspects that the Mystery Wreck's sheathing is likely to date to after Muntz's patent expired, i.e. post-1846. The presence of tiny amounts of lead in the Mystery Wreck sheathing samples also suggests a post-1846 date. To prove these dating theories conclusively, metallurgists are seeking to analyse more samples of Muntz and Muntz-type metal. Watch this space!.....

Absolute Dating methods result in a calendar date that can be related to the present day, for example: 1860 or 150 years ago. Absolute dates can be obtained using a range of scientific techniques such as dendrochronology (tree-ring dating) and radiocarbon dating. They can also be obtained from historical sources, for example a date on a coin, or a cannon.

Inscriptions on a coin will often indicate the year in which it was minted (see *Terminus post quem* Page 22). This provides an 'absolute date' for the minting of the coin. When metallurgists analyse the **composition** and physical structure of the coin's metal it gives us a snap-shot of how that type of metal looks for that particular date.

By comparing this snap-shot with a snap-shot of the metals from the Mystery Wreck, we can learn more about the probable date of the Mystery Wreck.

The composition of the Mystery Wreck metals were compared with the composition of metals from the following datable contexts:

- Copper bolts and sheathing from British ships from the Napoleonic War era
- Copper coins produced in Britain between the 1780s and 1835.
- Copper ingots found on 18th and 19th century shipwrecks in the Dorest area
- Data from shipwrecks in Australia
- A copper steam pipe produced in 1857 that was meant for a steam train but was lost at sea during delivery to Nova Scotia

Search for: 'metal ingots Earl of Abergavenny'

Search for: 'copper Sirius shipwreck'

Search for: 'Thomas shipwreck locomotives rcahms'



Bolts

Of the bolts retrieved from the Mystery Wreck site, some were found to be copper and some brass. Copper bolts were used in ship building between 1783 and approximately 1840 when brass bolts became more popular.

Copper Bolts

The copper bolts from the Mystery Wreck had a basic **composition** of arsenic, silver, bismuth and lead impurities which is typical for copper smelted in Britain in the later 18th and earlier 19th centuries from Welsh and Cornish ores. However, this date can be refined further. The level of arsenic in the Mystery Wreck copper bolts was found to be relatively low, which is also the case with the copper coins after about 1830 and the copper steam pipe (1857). This suggests a post-1830 date for the Mystery Wreck's copper bolts.

Brass Bolts (copper/zinc alloy)

Brass bolts become common in ship-building after 1840. The brass bolts from the Mystery Wreck, like the sheathing, have a zinc content lower than would be expected for Muntz Metal. This suggests a post-1846 date (i.e. after Muntz' patent had expired).

Why might the Mystery Wreck have had both copper and brass bolts?

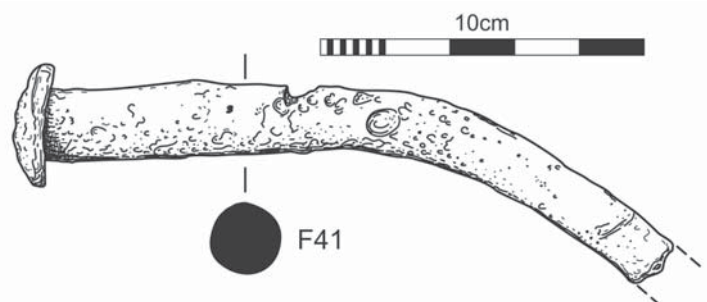

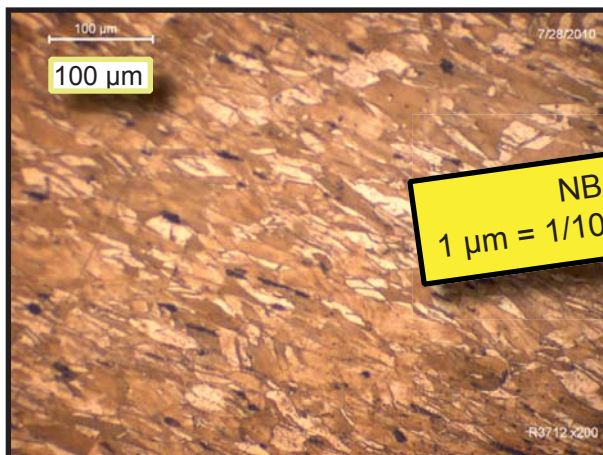

*Copper bolt as seen through an optical microscope.
Courtesy: Peter Northover*



*Brass bolt as seen through an optical microscope.
Courtesy: Peter Northover*

NB: scale-bars
1 μm = 1/1000th of a millimetre!

By looking at all the clues together, what can we learn about the Mystery Wreck?

Don't forget, a clue doesn't always tell us something useful!

Clue	Summary	What it tells us about the Mystery Wreck
1		
2		
3		
4		
5		
6		
7		
8		



You could use a table like this to summarise the information. Template available at www.hwtma.org.uk/mwtpdownloads

Summarising the clues



Archaeological investigation of the Mystery Wreck has revealed the following:

- The vessel is built of wood, reinforced with iron framing elements (knees).
- The hull is fastened using treenails as well as copper and brass bolts.
- The copper bolts are likely to have been manufactured within the UK after 1850
- The brass bolts are likely to have been produced after 1846
- The outside of the hull is sheathed in a Muntz-type metal likely to post-date 1846
- The vessel was probably at least 30m in length.

History in Action

Matching historic records to the finds on the seabed

The first step in trying to identify a wreck on the seabed is to check historic records of losses in the area.

National Monument Record Reported Losses

The National Monuments Record (NMR) is the public archive of English Heritage. It comprises 400,000 records of archaeological sites in England and its territorial waters. A significant proportion of records in territorial waters are reported losses for which no grid locations can be confirmed. Instead, these vessels are recorded at certain arbitrary points called Named Location (NLOs). These points represent general loss locations and do not (except by chance) relate to actual seabed remains.

The NMR can be freely accessed online, see the PASTSCAPE activity on page 29.

In trying to identify the Mystery Wreck, where information was not contained within the National Monument Record, it was possible to gain missing information by consulting the Lloyds Register, either for the year of sinking, or in some cases the year before.

Lloyds Register

Lloyd's Register of Shipping is a British publication that describes, classifies and registers ships for insurance purposes. The Registers date back to 1764 and include summary information relating to fastenings, hull sheathing and the dates that any changes may have been carried out.

Digitised pages from *Lloyd's Register of Ships* (1930 to 1945) can be viewed and searched online at:

www.plimsollshipdata.org/

Check out these resources on the PLIMSOLL Ship Data website:

Lloyd's Register of Ships and how it developed

How to use Lloyd's Register of Ships

DIY Ship Research

PLIMSOLL ShipData

You are here > [home](#) > [Home](#)

On this site

[Home](#)
[Ship searching tips](#)
[Help with PDFs](#)
[About this site](#)

Welcome to the site

PortCities Southampton - www.plimsoll.org - has digitised pages from Lloyd's Register of Ships from 1930 to 1945. You can search key data fields including ship name, year of build, weight and any former names of the vessel concerned. Search using the box below or read more about how the site was put together.

Search the ship database

Exact name:
or starts with: (Use this:)
Year of Build: Exactly
Gross Tonnage: Exactly

About the site

The site was created by the staff at the on-line resource about Southampton's history, the Plimsoll project - www.plimsoll.org for more details.

Comments

We would love to hear any comments, suggestions or general feedback you have

From Plimsoll.org

[About lloyds registers](#)



Find out the history of the registers and how they came about.

[Reading the registers](#)



Learn how to extract the hidden treasure from a lloyds register.

[DIY ship research](#)



PORTCITIES
UK Bristol Hartlepool Liverpool London Southampton
New and soon: [PortCities Southampton](#) > [Home](#)

Explore this site

Discover the story of Southampton between 1 over 1800 photographic documents, series and (top right of every page)

Southampton - Gateway

Discover the story of Southampton between 1 over 1800 photographic documents, series and (top right of every page)



Because ship remains can drift long distances from their reported location of loss, HWTMA searched historic records for losses within a 10km buffer zone of the site. In addition to the NMR records, other datasets consulted included:

- Hampshire’s Historic Environment Record (HER), the Isle of Wight SMR
- Historic Environment Records (HERs) are held by County, District or Unitary Authorities, they list information about finds, sites and areas of historic/archaeological significance- Sometimes they are referred to as Sites and Monuments Records (SMRs)
- the United Kingdom Hydrographic Office’s (UKHO’s) Wrecks Database containing approximately 70,000 records

The search of historic records revealed 303 reported losses (shipwrecks) dating from 1238 to 1944. The chart below summarises the 303 losses in relation to date range.



What date-range saw the highest amount of reported losses?
Why do you think this is?

What would be an appropriate tool for viewing and analysing the 303 reported losses?

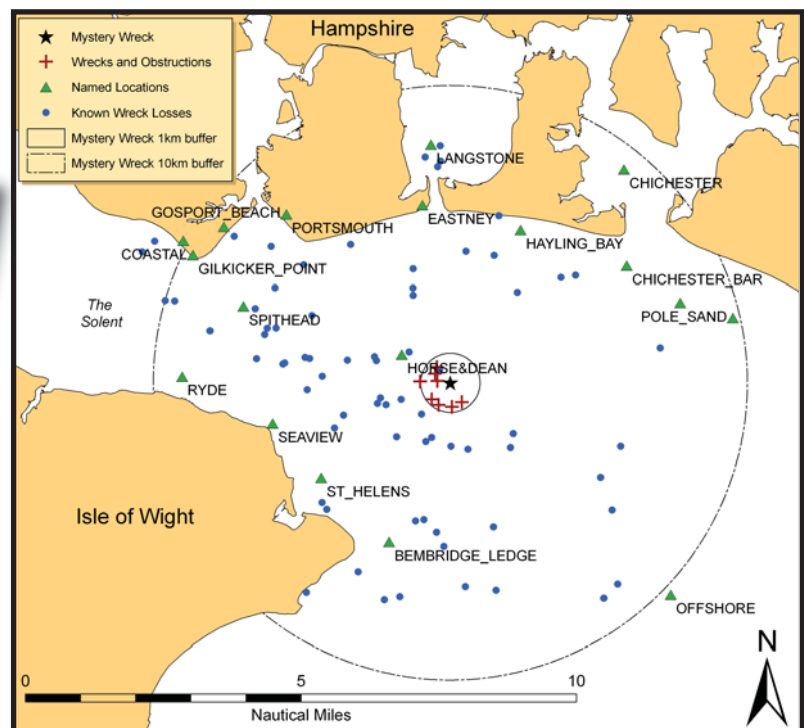

Known shipwreck and seabed obstruction locations lying within the Mystery Wreck 10km and 1km study area

Narrowing the field

The clues that we have gathered so far (summarised on page 25) enable us to refine the 303 historic records of ships lost in the vicinity of the study area down to a manageable level.

Answers:

Which of the 303 records can we discount?

- 1) *Wrecks classed as an aeroplane.*
- 2) *The Mystery Wreck can be classified as a wooden sailing merchant vessel, therefore any vessels that do not fit this criteria (eg. those with an engine, or constructed from iron/steel or composite construction, or carrying a significant armament) should not be considered.*
- 3) *The sheathing of the Mystery Wreck in Muntz Metal (known as yellow metal after 1846) is of particular significance as this could only have taken place after 1832. Consequently it is possible to remove all the vessels lost prior to 1832, or recorded as sheathed in a different material.*
- 4) *Any vessels that sank after 1832, but which were recorded as being sheathed in another material (eg. zinc) at the time of sinking may also be discarded.*
- 5) *The surveyed archaeological remains of the Mystery Wreck indicate a vessel of significant size. As such, it is not considered to represent the remains of a yacht or pleasure craft and such vessels were removed as candidates.*
- 6) *Cargo vessels listed as under 100 tons were also considered unlikely to fit the physical dimensions of the Mystery Wreck and were removed.*
- 7) *The survey of the vessel in conjunction with the metal analysis of the fastening has indicated that the Mystery Wreck was fastened with a combination of treenails and copper/brass-bolts. The latter were probably made between the late 1820s and the late 1840s. Accordingly, any vessels that are recorded in the Lloyds Register as being constructed with iron bolts were not considered further.*
- 8) *Some historical records of wreck events contain specific locational information relating to the event, eg. 'vessel wrecked on Southsea Castle beach'. In such cases, where the location explicitly does not relate to the Horse and Dean Sand, it is possible to remove the entry.*

The final contenders

Applying the above criteria narrows our field from 303 to.....5! These 5 are:

- *Colonist*, sank 1837, Spithead.
- *Hopewell*, sank 1838, Horse and Dean Sands.
- *Flower of Ugie*, sank 1852, Horse and Dean Sands.
- *Eastern Monarch*, sank 1859, Spithead.
- *Egbert*, sank 1867, Bembridge Ledge.

Basic information about sites listed in the National Monument Record can be freely accessed online via English Heritage's Pastscape website where it is possible to search for sites via location, themes, monument type and date/period. Searches can be narrowed by searching via a combination of criteria.



Try an 'Advanced Search' on Pastscape using information we've gained as a result of the archaeological research of the Mystery Wreck.

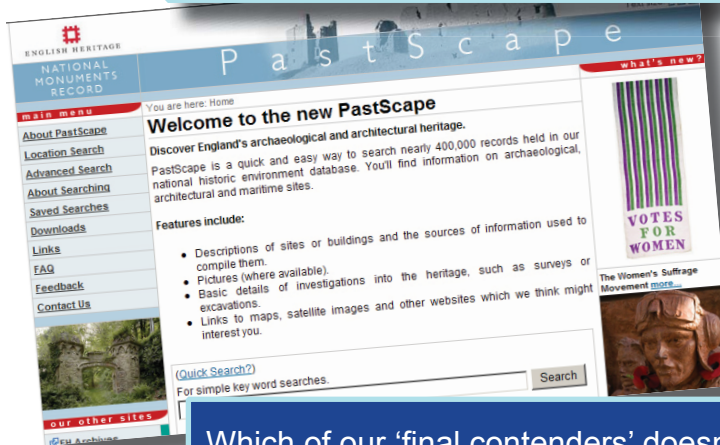

Cheat Sheet
 County: HAMPSHIRE
 District: PORTSMOUTH
 Search Themes: Maritime
 Specific Monument Type: wreck
 When: Between 1832 and 1870
 Results per Page: 60

Which of our 'final contenders' doesn't come up in your Pastscape search?
 Why do you think this is?
 Hint: Search for the missing 'final contender' by name in Pastscape

Elimination round

Using Pastscape, see what you can find out about the five 'final contenders' (listed on bottom of page 28). Which one do you think is most likely to be the true identity of the Mystery Wreck? Why do you think this?

The Lloyds Register (see page 26) provides the following information on the five 'final contenders':

Vessel	Year (Lloyds No.)	Master	Tons	Where	When	Home port	Survey port	Dest
Colonist S	1837-8 (588) F.S.&C.34	Smith	443	London	1811	Lon.	Lon.	Barb.
Hopewell	1837-8 (568)	Dixon	153			Sld.		
Flower of Ugie Bk	1852-3 (213) F&Y.M.51	Mather	350 402	Sld Srprs47	1838 &49	Sld.	Sld.	Aden
Eastern Monarch S	1858-9 (68) Y.M.&ptF.56c.f.	Morris	1844 1631	Dundee	1856	Lon.	Dundee	India
Egbert Bk	1865-6 (185)	Bushell	286	Sld.	1849	Shields	Sld.	Medit.

Abbreviations: S=Ship; SW=Snow; Bk=Barque. F.S.&C=Felt sheathed and coppered; F&Y.M.=sheathed with felt & yellow metal; c.f.=copper fastened; Srprs=some repairs, followed by year; Drp = Damage repaired, followed by year; Sld.=Sunderland; Lon.=London; Barb.=Barbados; Medit.=Mediterranean.

Consulting historic sources

Using the information from the Lloyds Register (bottom of page 29) and the Interesting Historical Facts (below), work through the questions below to try and work out the identity of the Mystery Wreck.

Interesting Historical Facts:

By referring to literature, historic and archaeological information on the period, we can determine the following:

A 150 ton ship from the mid 19th century would have been about 72ft (22m) long.

An 1844 ton ship from the mid 19th century would have been about 239ft (73m) long.

What do we know about the approximate length of the Mystery Wreck?

Which of the final contenders can be eliminated based on their tonnage/length?

According to the Lloyds Register, what was the Colonist sheathed with?

What do we know about the sheathing of the Mystery Wreck?

Interesting Historical Facts:

The *Isle of Wight Observer*, 23rd March 1867 reported that Egbert sank very rapidly on Bembridge Ledges. This is over three nautical miles to the south of the Mystery Wreck on Horse and Dean Sands. The ship was reported as sinking so rapidly that it began to break up before it could be reached by tugs. It is therefore very unlikely that Egbert could have drifted over 3 miles before finally coming to rest on the seabed as the Mystery Wreck.

Which of the 'five contenders' are sheathed in Muntz/Yellow metal?

This leaves one ship as the most likely identity of the Mystery Wreck, have you worked out which one? (see Page 37)

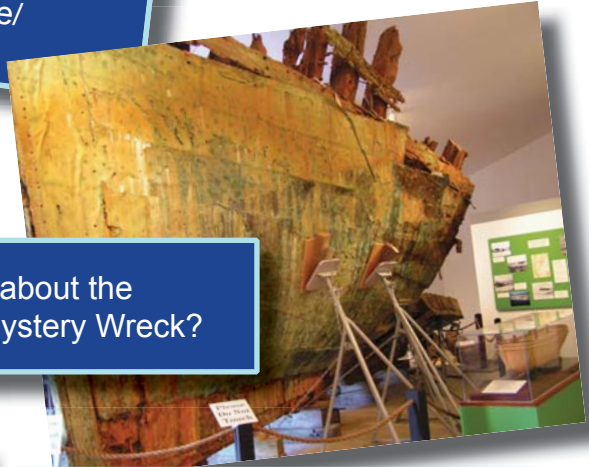
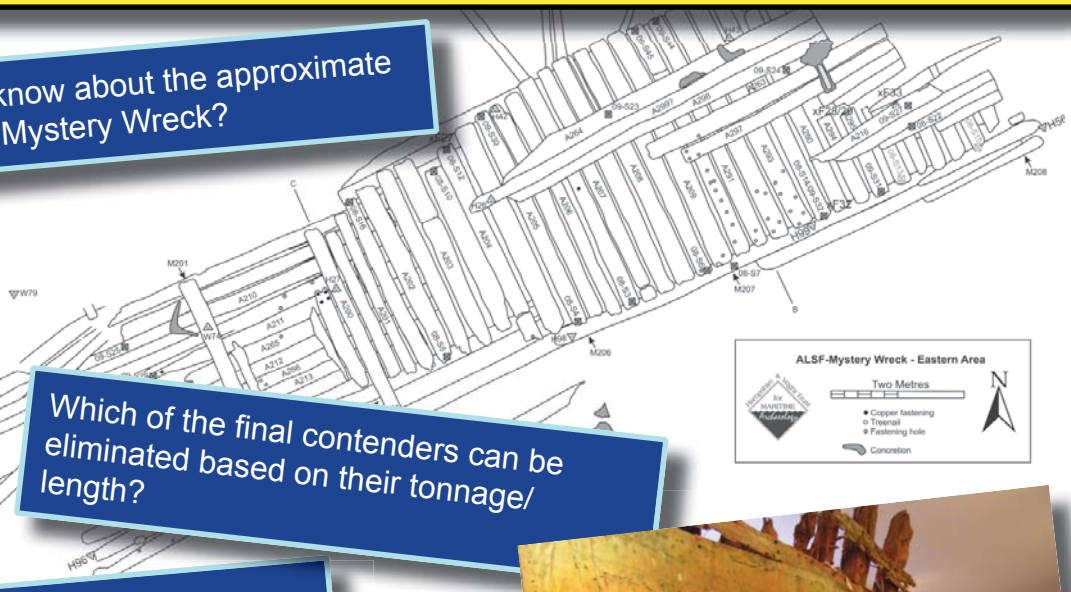



Marine Biology Case Study

Shipwrecks are not only of interest to archaeologists and historians for what they can tell us about the past. They're also of interest to marine biologists as a habitat and home to a myriad of species.

Marine habitats

Habitat means the physical and environmental conditions of the site, i.e. what the seabed is made of, such as hard rock or soft mud, whether it is deep or shallow, light or dark, in an area of strong currents or where there is little water movement. All of these components (and more) define the habitat.

Understanding the habitat is very important as it will determine what species are found, because all species have a habitat preference where they will be best suited to live.

Seabed Classification

There are various ways to classify what type of habitat exists at a site, the simplest way is just to define what the seabed is made up of as this has the greatest influence on what creatures may be found there. A habitat may be described as rocky reef, boulders, pebbles, sand, mud or even a wooden shipwreck.



Gravel seabed habitat
Photo: P. Naylor

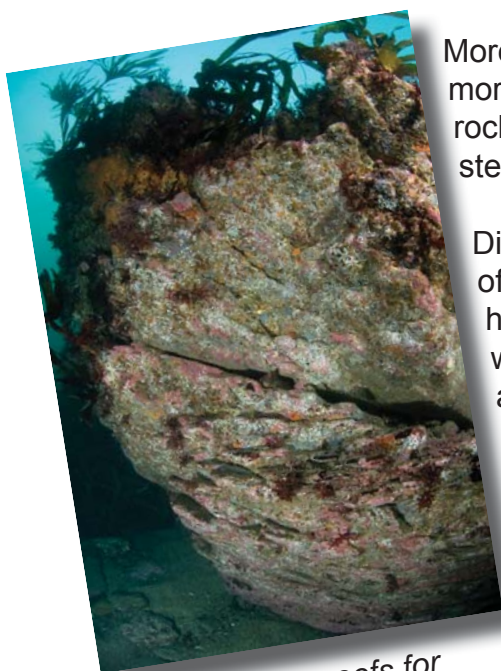

Rocky reefs for wildlife-rich habitats
Photo: Paul Naylor

More information can be added to make the habitat classification more specific and accurate, so a 'rocky reef' may become a 'soft rocky reef with vertical walls' as the hardness of the rock and the steep walls determines what species will live on it.

Different habitats support different types and different numbers of species. Rocky reef is the most diverse of all marine habitats because it is stable and doesn't get moved around by waves and currents, which allows lots of plants and animals to attach and grow. It is also a 'cryptic' habitat, often having lots of nooks and crannies for different species to take advantage of. In contrast, sand and mud habitats are home to far fewer species than rock because plants and animals can't attach as they will get washed away and there are fewer places for creatures to hide, instead, creatures must burrow for protection.

Do a virtual dive on the Mystery Wreck site and write a description of the marine habitat noting any species you see:
www.hwtma.org.uk/mwtpvideo



Shipwreck: a house or village

The presence of a shipwreck in any environment can have a significant impact on the number and type of marine species in the area. Shipwrecks can function like artificial rocky reefs because they have a hard surface for creatures to attach to and the structure of the ship can provide lots of places for animals to hide. If a shipwreck is on a sandy or muddy seabed it can act like an oasis of life and support different communities of creatures to the seabed around it, making wrecks an important habitat in their own right.

One location may contain several different habitats. A shipwreck for instance may have a flat deck, steep sides and even inside spaces in the ship's hull. Each of these areas will provide different conditions for the creatures to live in and therefore act as different habitats.

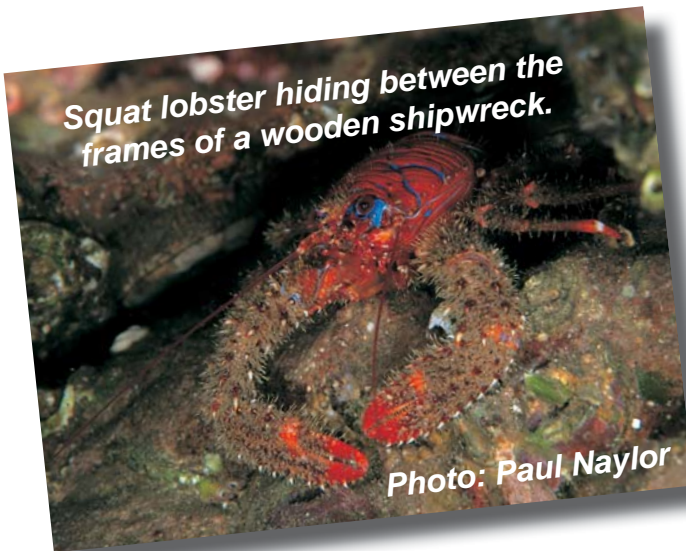

Lesser spotted catshark eggs ('Mermaid's Purse') attached to a shipwreck.

Habitat Survey

It is more difficult to survey what lives beneath the waves than what lives above them, specialist equipment and boats are required and bad weather, waves and tides can lead to delays. However, there are various techniques that are used including:

- Underwater video cameras to film what lives there
- Nets and trawls to catch what lives there and bring it to the surface for analysis
- Grab sampling, where a bucket like device is lowered to the seabed to gather some of the seabed and what lives on and in it
- Scuba diving, where divers visit the area to write notes on what they see and take samples

Research

Which habitat survey technique do you think would be most appropriate for the Mystery Wreck site which lies at a depth of approximately 10m on a sandy seabed, less than 10km south of Southsea, Hampshire, UK.

Search online for:

- SCUBA diving
- Grab sampling
- Trawl sampling
- Net sampling
- Remotely Operated Vehicle underwater survey





Species Survey

As well as habitat data, ecologists will record the different species they see and the number, or abundance, of them. We do this to discover if something is rare and unusual, or different from the surrounding area. There are thousands of different species in the seas around our coasts and it can be difficult to know exactly what they all are as many of them look very similar.

To help identify species we use a species classification system, which groups living things together according to how closely they are related, this is known as **taxonomy**. By looking at the characteristics of the plant or animal we can tell what group it fits in, which helps us work out what species it may be.

The diagram on the right shows the classification system we use. At the top is Kingdom, this is a very large group that may have thousands of different organisms, all distantly related, within it. As we work our way down the classification tree, through groups such as Phylum, Superclass and Class, the organisms that fit in to these groups become ever more closely related, until we get to the group Genus. Genus is a bit like a surname and only very closely related organisms will share the same Genus. After Genus we have Species, which is a bit like a first name and only one organism will have this name.

Plants and animals often have two names, a common name and a scientific name. The common name may be based on what the species looks like, such as dead men's fingers. The scientific name uses the genus and species, so dead men's fingers has the scientific name *Alcyonium digitatum*, it is Latin and is always written in italics.

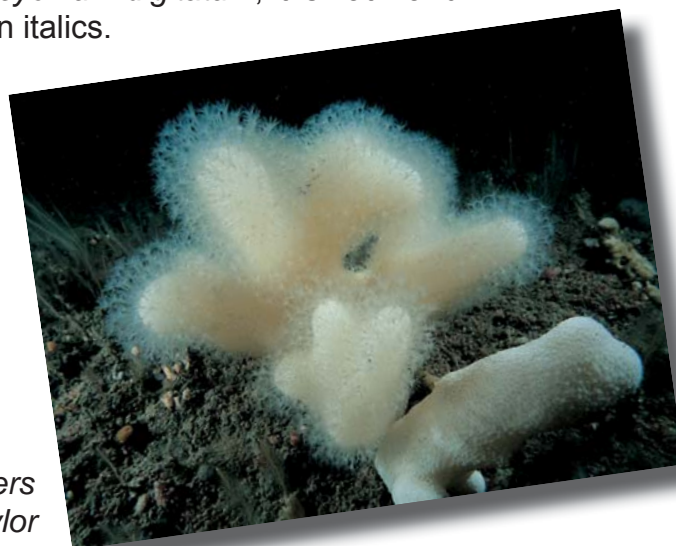

Dead men's Fingers
Photo: Paul Naylor

Taxonomy: the practice and science of classification

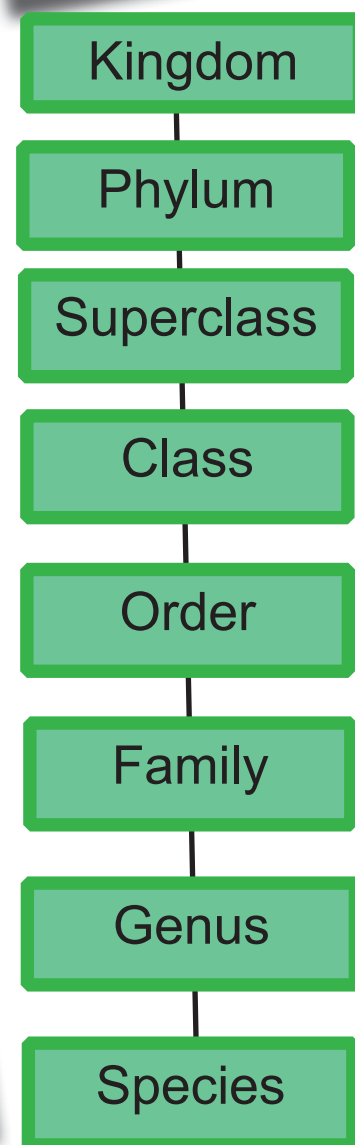

Mystery Wreck Marine Life Fieldwork and Survey

The Marine Habitat surveys on the Mystery Wreck enabled us to characterise and classify the habitats and species of the site and surrounding area. It is a shallow wreck site, between 8 and 10m. The wreck lies on a sandy seabed with some pebbles and broken shells. This means that the wreck itself provides a unique habitat, supporting a variety of creatures that would otherwise not live there.

Being shallow there is lots of light, meaning seaweeds cover much of the wreck, including a few large kelp plants.

There are also lots of animals living around the wreck, including:

Snakelocks, Dahlia anemone and Dead men's fingers (a type of coral).

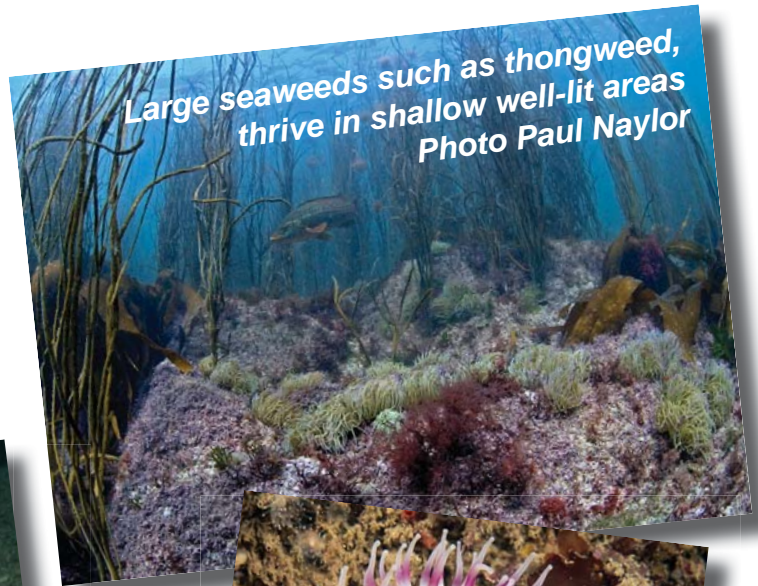

Large seaweeds such as thongweed, thrive in shallow well-lit areas
Photo Paul Naylor



A cuttlefish was also seen on the Mystery Wreck
Photo: Paul Naylor

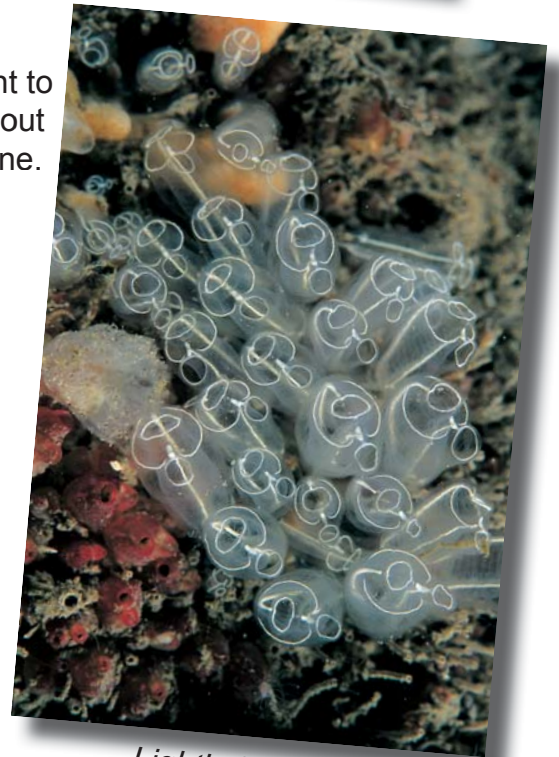

Photo: Paul Naylor

Dahlia anemone

Several types of seasquirts were found, these are thought to be the 'missing link' between more primitive animals without a back bone and more advanced animals with a back bone. Species included the lightbulb seasquirt and the starry seasquirt.

Numerous crustaceans were found, including lobsters, crabs and prawns, which like to hide in the nooks and crannies of the wreck.



Lightbulb sea squirt
Photo: Paul Naylor



Velvet Swimming Crab
Photo: Paul Naylor

All this sealife attracts lots of fish, which feed on the seaweeds and animals attached to the wreck. Seven species of fish were seen, including corkwing wrasse, a colourful fish species and one where the male will gather colourful bits of seaweed to furnish a nest in the wreck in the hope a female will be impressed with his interior design skills and lay her eggs there.



The most exciting find on the wreck was a short-snouted seahorse. This was actually found on the sandy seabed between the two main sections of the wreck. Seahorses are only rarely seen under water, this was the first time one has been seen by divers off the Hampshire coast and it was very unexpected. Seahorses are one of the few species of animals where the male gives birth, it is a nationally scarce species and the fish and their habitats are protected under the Wildlife and Countryside Act.

The presence of the wreck on an otherwise flat and fairly featureless seabed makes it an important maternity unit! The eggs of lesser spotted catshark, tompot blenny, cuttlefish, squid, common whelk, netted dogwhelk and necklace shells were all found.

Once we have finished our dives, we transfer the information on our slate to a recording form and go through our photographs, identifying species in them with the help of identification books and websites.

The Marine Life Information Network (MarLIN)

is an online database related to marine biodiversity and conservation. You can search for habitats and species in Britain and Ireland.

The species **taxonomy** is organised under:

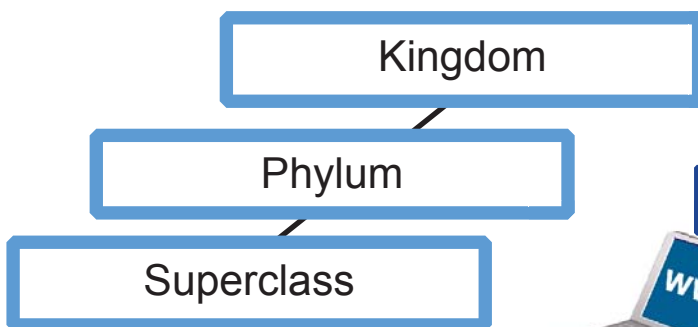

www.marlin.ac.uk/species.php





Use the MarLIN website to find the information to complete a spreadsheet like the one below for the following species found on the Mystery Wreck:

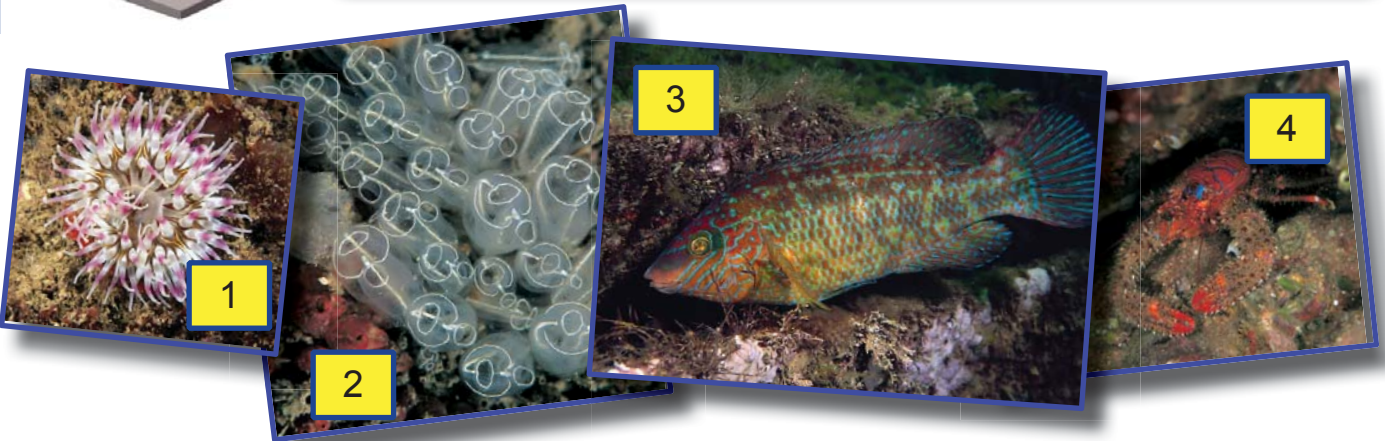

Pic.	Common Name	Phylum	Superclass	Scientific Name	Genus	Species
1	Dhalia Anemone	Cnidaria	Anthozoa	Urticina felina	Urticina	felina
2						
3						
4						

Template spreadsheet and table available at www.hwtma.org.uk/mwtpdownloads

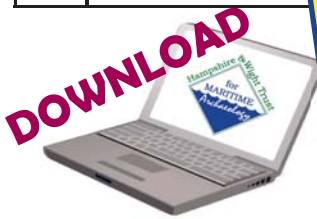

Advanced: look at the 'Advanced review' sheet for each species to find out the Class, Order and Family for each species. Update your spreadsheet with this information.

With help from the MarLIN website, complete additional rows in your spreadsheet, but leave out the Common Name, see if a friend can work out the Common Names.....

Ecological data, such as that collected from the Mystery Wreck, is very important. It helps us to map what plants and animals live where, highlight where scarce species such as seahorses live and understand how important particular habitats are in relation to the habitats around them. This knowledge is then given to the Government to help protect the habitats and species for activities that may damage the site.

The Mystery Wreck is considered to be an important area for plants and animals as lots of species occur here that would not usually be found in this otherwise sandy and gravelly area. There are various ways of protecting sites like this wreck to enable the wildlife to flourish.

A new way of protecting important wildlife sites is to make them Marine Conservation Zones (MCZs). A new law, the Marine and Coastal Access Act, was passed by Government in 2009. It means that for the first time we can protect important sites for marine wildlife around England, this can include ship wrecks. The data gathered for the Mystery Wreck site is now being analysed by conservation organisations to see if it is important enough to become a Marine Conservation Zone, if it does then it will protect the wildlife from damaging activities so it can continue to flourish. Of course, this would also protect the archaeology of the Mystery Wreck.

Search online to find out more about the 'Marine and Coastal Access Act'



Archaeological, historical and scientific evidence all points towards the identity of the Mystery Wreck being the **Flower of Ugie**

The Lloyds Register of British and Foreign Shipping contains an entry for the *Flower of Ugie* that represents each year of the vessel's use, from its building in 1838 to its sinking in 1852.

Each year the register lists basic information for a given ship including vessel name, master, tonnage (old and new tons), build details (where and when), current owners, port belonging to and destined voyage. In addition there may be details of the vessel's hull and stores and basic information about the vessel's rig, fastenings, sheathing, repairs and the port where the ship was surveyed.

By studying the Lloyds Register for each year, from the year of build to the year of sinking, we are able to reconstruct the basic history of the *Flower of Ugie* over the course of its fourteen years of operation.

The *Flower of Ugie* was a barque-rigged sailing vessel built in Sunderland, UK in 1838. The ship sailed all over the world, transporting goods to and from destinations including Cape of Good Hope, Odessa, Mauritius, Quebec and Aden.

A barque-rigged sailing vessel built in Sunderland in 1843.

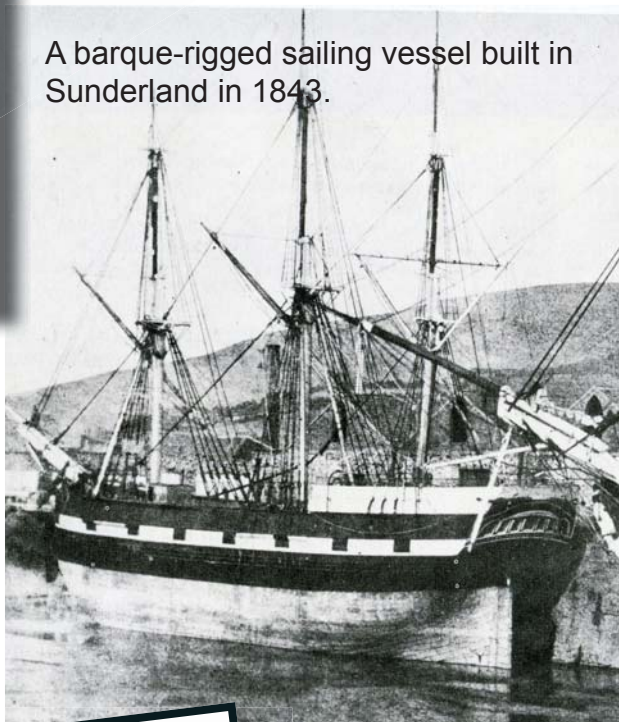

To find out about the voyages of the *Flower of Ugie* we can look at newspapers from the time. These can include reports of newsworthy and often dramatic events such as shipwrecks but also more mundane but very revealing items such as daily reports of shipping movements.

The Times
21st January, 1841

SHIP NEWS.
EAST INDIA SHIPPING.
The Indus, from Bengal, has arrived off Waterford, sailed August 12, and from St. Helena Nov. 17.
The *Flowers of Ugie*, from Bengal, has arrived off Liverpool, sailed Sept. 8, and from St. Helena Nov. 23.
The Leonard Dobbins, from Bombay, has arrived off Liverpool, sailed Sept. 28, and from St. Helena Nov. 30.

The Times

Wednesday December 29th 1852

You can view 19th century newspapers online via the British Library website. Search for 'British Library Newspapers' and try entering 'shipwreck' into the FIND box (select 'Display only free content').



At a late hour on Sunday night a severe gale began to blow at Portsmouth from the S.S.W., and, as the night advanced it so increase in violence as to become a perfect hurricane. The wind was accompanied by deluges of rain, which flooded the streets and the moats of the fortifications. At an early hour this morning guns, evidently from some vessel in distress, were heard, but owing to the high wind it was almost impossible to ascertain from what direction they proceeded. They, however, doubtless proceeded from a trader named the *Flowers of Ugie*, Captain Mather, bound from Sunderland to Carthage, which, unfortunately, was driven on the Deans, a dangerous bank about five miles to the eastward of this port. The crew, in order to ease and lighten her, cut away her masts about 4 this morning, and used every effort in their power to save the vessel, cargo, and their own lives. They were, however, ultimately compelled to abandon her, taking refuge on board a pilot boat, by which they were safely brought into this port at noon to-day. The hull of the abandoned vessel was knocked about all day on the Deans till this afternoon, when all remnant of her disappeared.

Aggregate Levy Sustainability Fund (ALSF) funding, distributed by English Heritage and the Marine Environmental Protection Fund (MEPF), has enabled fieldwork and historic research of the Mystery Wreck and the production of this educational resource.



Since 2002, the Aggregates Levy Sustainability Fund (ALSF) has initiated a host of research projects that have generated a much better understanding of sustainability within the industry and the ways in which it can be achieved. Environmental knowledge collected through ALSF funded research is used not only by those making decisions about the aggregate industry but in a much wider context as well. The research is organised under four themes:

Theme 1 - Reducing the Environmental Effect

Theme 2 - Sustainable Provision of Aggregates

Theme 3 - Creating Environmental Improvements

Theme 4 - Heritage

Further information can be found at:

www.alsf-mepf.org.uk and www.english-heritage.org.uk

Mineral Wealth - Seabed Health

A website with an extensive collection of videos, interactive units and activities about the marine environment and the aggregate industry:

www.mineralwealth-seabedhealth.org/

Thames REC GIS

See the results from another ALSF funded research project online at:

www.thamesrecgis.org.uk/



Use your GIS skills (see page 6-8) to view the wrecks off the east of England. What other information can you learn about the marine zone from this online GIS?

Thames REC Interpretation & Analysis WebGIS

Layers

- Survey Positions
- Ecological Characterisation
- Habitats & Biotopes
- Geology & Heritage
 - Regional Bathymetry (SeaZone)
 - Seabed Sediments
 - Seabed Morphology Zones
 - Bedforms
 - Sediment Transport
 - Direction
 - Inferred Sediment Transport Direction
 - Saalian Glacial Limit
 - Elsterian-Anglian Glacial Limit
 - Elsterian-Anglian (modified) Glacial Limit
 - Devensian Glacial Limit
 - Enclosed Deepes
 - Plateau Margin
 - Interpreted Channel
 - Systems
 - Terrestrial Section of River System (OIS 6-4)
 - Terrestrial Section of River System (OIS 8-6)
 - Terrestrial Section of River System (OIS 12)
 - Terrestrial Section of River System (OIS 12-10)
 - Terrestrial Section of River System (OIS 18)
 - Wrecks
 - Post Medieval
 - Modern
 - Unknown
 - Background Data

Map

Find: Fareham

Next Previous Highlight all Match case

Source: NMR data supplied by English Heritage, 2008
Source: © Crown Copyright and/or database rights. Reproduced by permission of the Controller of Her Majesty's Stationery Office and the UK Hydrographic Office (www.ukho.gov.uk)

WGS84/UTM 31N 288625, 5796626

Query results
No results were found

Summary

Shipwrecks are located all over the world, each having a unique story embedded within a particular social, political and technological context. This resource shows how the study of a shipwreck involves many subjects, specialisms, disciplines, industries and often countries.

In the case of the Mystery Wreck, archaeologists, marine biologists, the marine aggregate industry and a range of scientists have worked together in the marine zone, offices and laboratories, using a variety of tools and methods.

While the history of a ship and the reason for its sinking often provides a fascinating story, a shipwreck's story never ends as it continually evolves as a heritage asset, site of interest, marine feature and habitat.

The story of the investigation of the Mystery Wreck and its identification as the *Flower of Ugie* is by no means unusual. It does, however, provide an example of how industries, disciplines and nationalities work together in a modern global community where interdependence, environmental interaction and sustainable development are key.

We hope you have enjoyed helping to solve the mystery of the *Flower of Ugie*.

Acknowledgements

HWTMA are extremely grateful for the support and resources provided by:

Marine Environment Protection Fund.

English Heritage.

Jolyon Chesworth, South East Marine Conservation Manager, Hampshire & Isle of Wight Wildlife Trust.

Dr Justin Dix, National Oceanography Centre, Southampton, University of Southampton

Molly O'Guinness Carlson, Archaeological Conservator/CEO, Head Tide Archaeological Conservation Laboratory, 35 Sheepscot Shores Road, Suite A, Wiscasset, Maine, 04578 USA.

Lynne Harrison, Testbourne Community School

Dr Peter Northover, Oxford Materials Characterisation Service.

Dave Hooley, English Heritage (for the Seascapes image on page 1).

Wessex Archaeology (for the images on page 5)

The *Alex Van Opstal* images on page 10 were produced using data from DORIS (DORset Integrated Seabed survey), a collaborative project involving Dorset Wildlife Trust, The Maritime and Coastguard Agency, Channel Coastal Observatory and the Royal Navy, with major funding from Viridor Credits Environmental Company. Other partners include Natural England, Dorset Strategic Partnership, the National Oceanography Centre and University of Southampton.

Answers (question & answer sheets downloadable at www.hwtma.org.uk/mwtpdownloads)

See below for answers to questions throughout this booklet. Answers listed with reference to page number. NB, Downloadable Question and Answer sheets are also available at: www.hwtma.org.uk/mwtpdownloads).

PAGE 5: A) Base of a Roman pottery bowl, B) Telescope, C) Mammoth's tusk, D) Parts from a crashed aircraft.

PAGE 8: Number of dives: 16, Number of ordnance artefacts: 1.

PAGE 14: *Why should the study of shipwrecks benefit from international archaeologists working together?* Answer: ships travelled the world as the main vehicle for international trade, migration and warfare.

PAGE 16: *What advantages do you think treenails might have over metal fastenings?*
Answer: Being made of wood they don't rust, weigh less, were cheaper, didn't damage ships' timbers as much, swelled when wet to form a tighter fit, were easier to come by, were not a problem when other holes needed to be drilled through in the vicinity.

PAGE 17: *Why do you think 'cut' knees became more common than 'grown' knees?*
Answer: it became harder to find appropriate trees for grown knees.

PAGE 17: *What advantages do you think iron knees would have over timber knees?*
Answer: iron knees were stronger and more compact.

PAGE 18: Find 29: Pieces of slag/coke, Find 25: Rim of a hand-bell. Copper alloy with decoration, Find 24: Scraps of Copper/alloy sheathing with punch-holes (for securing to ship's hull with large-headed nails), Find 33: Possible top for a sugar-shaker or muffineer. Silver or pewter. May have been a personal possession, part of the ship's galley inventory or cargo. Find 41: A bent copper/alloy bolt. Probably used in the construction of the ship.

PAGE 19: *Solving the problem of marine organisms attaching themselves to ships' bottoms has always been particularly important to the Royal Navy. Why do you think this is?*
Answer: with cleaner bottoms ships are faster, more manoeuvrable and spend less time out of action due to hull repairs.

PAGE 21: *In 1708 the Royal Navy rejected the idea of copper sheathing for their ships, deciding that the amount of work involved and cost was too high. What do you think made them change their mind towards the end of the 18th century?*
Answer: towards the end of the 18th century, with the Royal Navy engaged in the American war of independence (1775–1783), declarations of war on Britain from France (1778), Spain (1779) and the Netherlands (1780) meant that the Royal Navy faced arguably the greatest threat to date. Fast ships that could stay at sea for long periods were essential to defending Britain against threats posed by its combined enemies.

PAGE 21: *What are some important questions to consider when deciding if an invention is successful or not?*
Some answers: Does it work? What are the benefits? What are the alternatives? Can the expense be justified? Are materials available? Are there any bad side-effects? etc.

Answers continued

PAGE 24: *Why might the Mystery Wreck have had both copper and brass bolts?*

Answer: it was probably originally built using copper bolts and subsequent repairs would have used the more modern bronze bolts.

PAGE 27: *What would be an appropriate tool for viewing and analysing the 303 reported losses?*

Answer: Geographical Information Systems (GIS). See page 6-8 for further information about GIS.

PAGE 27: *What date-range saw the highest amount of reported losses? Why do you think this is?*

Answers: Increased amounts of shipping.
Improved procedures for reporting and recording

PAGE 29: *Using PastScape, see what you can find out about the five 'final contenders' (listed on bottom of page 28). Which one do you think is most likely to be the true identity of the Mystery Wreck? Why do you think this?*

Student to answer with their own reasoning.

PAGE 29: *Which of our 'final contenders' doesn't come up in your PastScape search? Why do you think this is?*

Hint: Search for the missing 'final contender' by name in PastScapes

Answers: Egbert is listed in PastScapes under County: ISLE OF WIGHT and we were searching under HAMPSHIRE.

PAGE 30: *What do we know about the approximate length of the Mystery Wreck?*

Answer: the Mystery Wreck was approximately 30m long.

PAGE 30: *Which of the final contenders can be eliminated based on their tonnage/length?*

Answers: Hopewell, at 150 tons, would have been smaller than the Mystery Wreck. The Eastern Monarch at 1844 tons would have been much larger than the Mystery Wreck.

PAGE 30: *According to the Lloyds Register, what was the Colonist sheathed with?*

Answers: F.S.&C = Felt sheathed and coppered

PAGE 30: *What do we know about the sheathing of the Mystery Wreck?*

Answer: the Mystery Wreck was sheathed in a Muntz-type metal (Yellow Metal) rather than copper. This means the Mystery Wreck is unlikely to be the Colonist.

PAGE 30: *Which of the 'five contenders' are sheathed in Muntz/Yellow metal?*

Answer: Egbert, the Flowers of Ugie and The Eastern Monarch (but we know it can't be Eastern Monarch due to the size).

PAGE 30: *This leaves one ship as the most likely identity of the Mystery Wreck, have you worked out which one?*

Answer: the *Flower of Ugie!*

Identifying a Mystery Shipwreck

A cross-curricular resource for KS3

Shipwrecks are located all over the world, each having a unique story embedded within a particular social, political and technological context. This resource shows how the study of a shipwreck involves many subjects, specialisms, disciplines, industries and countries.

Subject relevance:

- ICT
- Science
- History
- Geography
- English
- Design/Technology
- Citizenship

DOWNLOADS

WEB LINKS

This resource was developed and produced by the:
Hampshire and Wight Trust for Maritime Archaeology

Room W1/95 National Oceanography Centre
Empress Dock
Southampton
SO14 3ZH

Tel: 02380 237300

Email: info@hwtma.org.uk

www.hwtma.org.uk

Marine
Aggregate Levy
Sustainability Fund
MALSF

